

®

RCBS

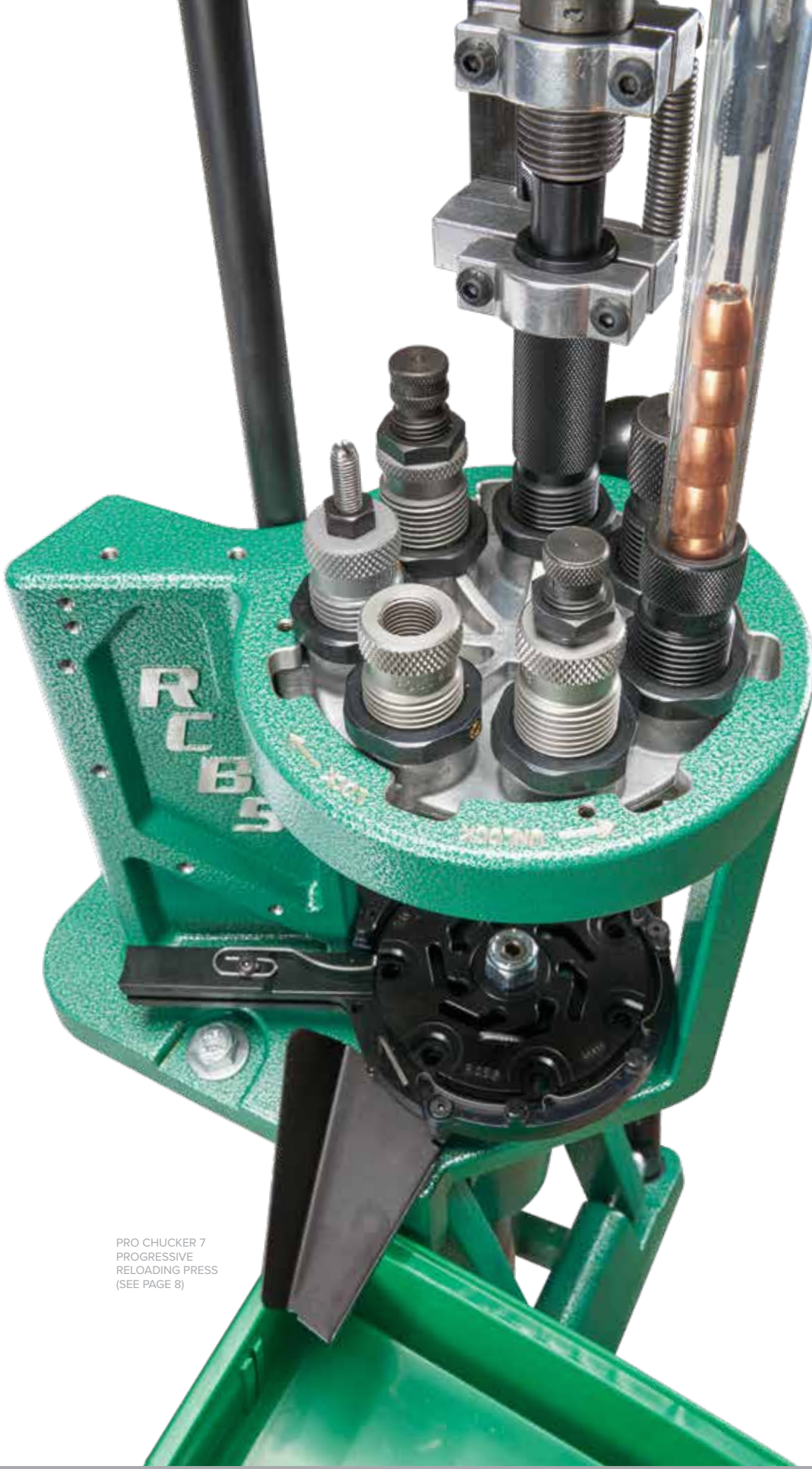

PRO CHUCKER 7
PROGRESSIVE
RELOADING PRESS
(SEE PAGE 8)

PRECISIONEERED RELOADING SINCE 1943

NEW PRODUCTS	4-5
SINGLE STAGE PRESSES	6-7
PROGRESSIVE PRESSES	8-11
PRESS ACCESSORIES	12-14
PRESS KITS	15-16
CASE PREP	17-25
CASE TRIM	26-28
PRIMING	29-31
SCALES + ACCESSORIES	32
POWDER HANDLING	33-39
SHELL HOLDERS	40-41
REFERENCE CHARTS	42-43
RELOADING DIES	44-53
SPECIAL ORDER	54
SHOTSHELL	55-56
BULLET CASTING	57-62
MISCELLANEOUS	63

LIFETIME WARRANTY (LIMITED TO ORIGINAL OWNER)

RCBS® Presses, Dies, and mechanical accessories, (does not include electric-powered accessories), are warranted to be free from defects in material or workmanship for as long as the original owner owns it.

ONE YEAR LIMITED WARRANTY

RCBS® electronic accessories (digital scales, ultra-sonic equipment, etc.) are warranted to be free from defects in material or workmanship for a period of one year from date of purchase.

TWO YEAR LIMITED WARRANTY

RCBS® AC electrical-operated accessories (Trimmers, Tumblers, Furnaces, etc.) are warranted to be free from defects in material or workmanship for a period of two years from date of purchase.

FOR FULL WARRANTY DETAILS VISIT RCBS.COM/WARRANTY

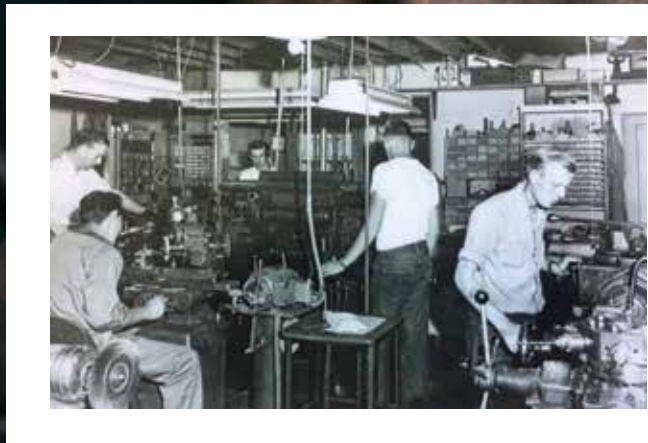



RCBS WAS FOUNDED FROM A HOBBY BY FRED T. HUNTINGTON IN 1943

RCBS was founded in 1943 by Fred T. Huntington in Oroville, California. Huntington was a dedicated shooter, but found it difficult to obtain quality varmint bullets. However, after reading about making a die to swage .22 rimfire cartridge cases to form jackets for bullets, he began to craft his own dies in the back room of his father's Oroville laundry and dry-cleaning business. Because the resulting bullets were used to shoot rock chucks – a varmint of Western North America – he named them Rock Chuck Bullet Swage dies, later shortened to RCBS.

RCBS soon outgrew this modest beginning in the back of a laundromat, and by 1948 Huntington relocated to a small shop. The business continued to grow rapidly, spilling into his garage and then a new building in 1954. By 1958, RCBS was expanding again, first to a 7,500-square-foot factory that quickly grew to 50,000 square feet. As the years passed, more expansions have occurred, but RCBS stayed near its roots. Today, Oroville is still RCBS' home for state-of-the-art production.

And while RCBS no longer manufactures bullet-swaging dies, we are the leading manufacturer of ammunition reloading equipment for rifles and pistols, offering reloading equipment throughout the world. Learn more at rcbs.com.



HERE'S THE LATEST FROM RCBS



NEW

BRASS BOSS

Get brass ready to reload quickly and easily with Brass Boss.

- Six variable, high-speed rotating stations (four at <350 rpm; two at <550 rpm)
- Two fixed stations for case neck brushes
- Tools included for all stations
- Storage area for tools not in use
- 120-240 VAC for operation in multiple countries
- US, UK, EU and Australian power cords
- 2-year limited warranty

See page 26

NEW

CHAMBER/CARTRIDGE LENGTH GAUGES

Check chambering and cartridge length with RCBS Chamber/Cartridge Length Gauges.

Available in the following sizes:

- 9MM
- .38 Special
- .40 S&W
- .45 ACP
- .45 COLT
- .223 REM/5.56X45
- .308 WIN/7.62X51
- 300 AAC BLACKOUT
- Limited lifetime warranty.

See page 12



NEW

VLD 3-WAY CARBIDE CUTTER

Chamfer, deburr, and trim case to length - all at the same time!

- Attaches easily to RCBS Case Trimmers and Trim Pros
- Limited lifetime warranty

See page 27



NEW

RELOADING DIES

New Group C dies for .450 Bushmaster and Group D sizer die for 6MM Creedmoor

See pages 44-53

SINGLE STAGE PRESSES

A



B



A ROCK CHUCKER® SUPREME PRESS

The Rock Chucker® Supreme press loading window is a spacious 4.25" to allow easy loading of today's longer cartridge designs. This press has easy operation, ambidextrous handle, outstanding strength and versatility. The Rock Chucker Supreme is ideal for the beginner and pro alike.

- 9356 ROCK CHUCKER SUPREME PRESS
- 9552 PRIMER PLUG, SLEEVE & SPRING (LARGE)
- 9553 PRIMER PLUG, SLEEVE & SPRING (SMALL)
- 86881 DUST COVER
- 9358 ROCK CHUCKER SUPREME AUTO PRIME

B SUMMIT™ SINGLE STAGE RELOADING PRESS

Unlike other presses, the Summit™ operates on top of the bench; the case does not move, the reloading die comes down to the case. Its all-steel linkage and cast iron frame provide the stability and ruggedness all reloaders need. The ambidextrous design allows unprecedented access to your cases, and you can quickly change dies. The Summit also offers compound leverage, a massive 2" diameter ram, full frontal access, a press adapter bushing, zerk fitting for lubrication, spent primer catcher and 4.5" operating window for convenient access. It accepts bushings for 1" die bodies and is made in the USA.

- 9290 SUMMIT SINGLE STAGE RELOADING PRESS
- 9291 SHORT HANDLE-SUMMIT RELOADING PRESS
- 9294 ARBOR DIE CONVERSION KIT
- 86881 DUST COVER

C



C ARBOR DIE CONVERSION KIT

Get even more from the RCBS® Summit™ single-stage reloading press with the Arbor Die Conversion Kit. By replacing the Summit's standard die bushing and shell holder adapter, the kit creates two flat, parallel mounting surfaces—ideal for benchrest-type arbor dies. The Arbor Die Conversion Kit comes with a limited lifetime warranty and is made in the USA.

- 9294 ARBOR DIE CONVERSION KIT (FOR 9290)

SINGLE STAGE PRESSES

D



D RELOADER SPECIAL — 5 PRESS

The latest in our popular line of Reloader Special™ presses. Featuring a more comfortable ball handle and a primer arm that lets you prime cases at the same time you resize. Cast Aluminum frame and toggle block, steel links, 4.3" operating window with a 3.4" ram stroke.

9285 RELOADER SPECIAL—5 PRESS
86881 DUST COVER

E



E PARTNER PRESS

Just starting out? The Partner™ Press is easy to use and incredibly durable. Our least expensive press offers big performance in a compact package. It's also perfect as a second press for different operations or a portable press for use at the range. 4" Window, 3.5" Stroke.

87460 PARTNER PRESS
86881 DUST COVER

F



F AMMOMASTER™ —2 SINGLE STAGE PRESS

The AmmoMaster—2 single stage press has longer support columns and larger toggle block found on our AmmoMaster .50 BMG press. While still set up to use standard 7/8"-14 thread dies and standard shell holders to load most any pistol or rifle caliber, the addition of the .50 BMG 1-1/2" Die Kit (88705) will allow you to load from .25 ACP to .50 BMG.

For original AmmoMaster owners wishing to load .50 BMG, two kits are necessary. The .50 BMG 1-1/2" Press Conversion Kit and the .50 BMG 1-1/2" Die Kit.

The Press conversion kit contains the larger toggle block and support columns and the Die Kit contains a Full Length Size Die, Roll Crimp Seat Die, Trim Die, .50 BMG Shell Holder and .50 BMG Ram Priming Unit.

88703 AMMOMASTER—2 SINGLE STAGE PRESS
88705 .50 BMG 1-1/2" DIE KIT
88709 .50 BMG 1-1/2" PRESS CONVERSION KIT (FOR 88701 AMMOMASTER)
88772 .50 BMG RAM PRIMING UNIT
88746 .50 BMG SHELL HOLDER

PROGRESSIVE PRESSES



A PRO CHUCKER 5 PROGRESSIVE RELOADING PRESS

The RCBS® Pro Chucker 5 Auto Index Progressive Press features five-station automatic indexing for maximum production, with a load rate of approximately 600 rounds per hour. The quick-change die plate allows fast caliber change over for even greater efficiency. Standard primer pick up tubes are used with the safety shielded priming system. Spent primers are efficiently dropped from the bottom of the press to be captured in a trash receptacle. The powder measure is fitted out with Quick Change metering components that allow you to drain powder without removing the measure from the press. You can also quickly swap out preset metering screws for dispensing the new powder.

Accessory Base Plate not included.

88910 PRO CHUCKER 5 PROGRESSIVE PRESS
86885 DUST COVER

B PRO CHUCKER 7 PROGRESSIVE RELOADING PRESS

The first seven-station auto-indexing press on the market, the RCBS Pro Chucker 7 features automatic indexing for maximum production, with a load rate of approximately 600 rounds per hour. The quick-change die plate allows fast caliber change over for even greater efficiency. Standard primer pick up tubes are used with the safety shielded priming system. Spent primers are efficiently dropped from the bottom of the press to be captured in a trash receptacle. The larger powder capacity Quick Change powder measure reduces the number of times you have to fill the powder hopper. The Quick Change drain tube allows you to drain the powder measure without removing it from the press and the QC metering assemblies allow shortened set up times when switching powders. Seven stations allows you to progressive load any way you want. You can seat bullets and crimp separately. Use a pistol bullet feeder but also use a Lock-Out or Powder Checker die. With seven stations, you can install them all.

Accessory Base Plate not included.

88911 PRO CHUCKER 7 PROGRESSIVE PRESS
86885 DUST COVER

PROGRESSIVE PRESSES

C



E



D



F



C PRO CHUCKER 7 DIE PLATE

Change calibers quickly and easily by leaving the reloading dies set up for a caliber-specific plate.

88917 PRO CHUCKER 7 DIE PLATE

E PRO CHUCKER 5 DIE PLATE

Make caliber changes quickly and easily. Leave the reloading dies set up. Eliminates the need to install and adjust dies for each reloading session.

88912 PRO CHUCKER 5 DIE PLATE

D POWDER DIE

The Powder Die allows the Case Activated Powder Measure (CAPM) to be quickly moved from one Die Plate to another.

98912 POWDER DIE

F POWDER DIE FUNNEL ADAPTER

RCBS Funnel adapter takes the place of the Case Activated PM. This allows placement of a funnel onto the Powder Die to pour measured charges into the case for greater accuracy. Limited lifetime warranty.

98913 POWDER DIE FUNNEL ADAPTER

PROGRESSIVE PRESSES



See Reference Chart on page 40-41 to determine the Shell Holder number required for caliber.

PRO CHUCKER 5 TO 7 CONVERSION KIT (NOT PICTURED)

When you are ready to upgrade your Pro Chucker 5 to seven-station operation, the Pro Chucker 5 to 7 Conversion Kit has everything you need. It includes a seven-station die plate, shell plate holder assembly, large and small priming system, Quick Change powder measure and case activated linkage kit.

88914 PRO CHUCKER 5 TO 7 CONVERSION KIT

G

PRO CHUCKER 5 SHELL PLATE

Plate Size	Part Number
Number 2	88920
Number 3	88921
Number 4	88922
Number 6	88923
Number 10	88924
Number 11	88925
Number 12	88926
Number 13	88927
Number 14	88928
Number 16	88929
Number 17	88930
Number 18	88931
Number 19	88932
Number 20	88933
Number 23	88934
Number 27	88935
Number 30	88936
Number 32	88937
Number 35	88938
Number 38	88939
Number 39	88940
Number 43	88941
Number 44	88942
Number 45	88943
Number 48	88944

H

PRO CHUCKER 7 SHELL PLATE

Plate Size	Part Number
Number 2	88950
Number 3	88951
Number 4	88952
Number 6	88953
Number 10	88954
Number 11	88955
Number 12	88956
Number 13	88957
Number 14	88958
Number 16	88959
Number 17	88960
Number 18	88961
Number 19	88962
Number 20	88963
Number 23	88964
Number 27	88965
Number 30	88966
Number 32	88967
Number 35	88968
Number 38	88969
Number 39	88970
Number 43	88971
Number 44	88972
Number 45	88973
Number 48	88974

PROGRESSIVE PRESSES

I



I TURRET PRESS

Simple operation—no complex or automated processes. You have complete control over every reloading step. May be operated in progressive or single-stage mode.

In the progressive mode, output can be increased from 50 to 200 rounds per hour. Or, if preferred, the press can be used as a single-stage press and load cases in the batch mode.

Rugged, cast iron frame, toggle block and turret head. Heavy-duty construction to minimize deflection. Detent on Turret Head for positive alignment. Standard 7/8"-14 threads for most popular reloading dies and accessories. Six-Station Turret Head allows many combinations in the mounting sequence of dies and powder measure permits two or more calibers to be set up at the same time. Turret Head held in place by one bolt for quick, easy changeovers. Turret Pin Assembly (provided for turret head removal and installation) and Ball Handle Assembly may be positioned for right or left-hand use. Standard Shell Holders slip into press ram and are securely held in place by a clip spring.

Primer Plugs and Sleeves are supplied for seating large and small primers. Primers are seated away from stacked primers. Safety tube included.

The Primer Catcher eliminates spent primers on floor—snaps off for easy emptying. Baked powder coat finish for quick, easy cleaning, chip and fade resistant. 4.75" Window, 4.5" Stroke.

Accessory Base Plate not included.

88901 TURRET PRESS

J



J TURRET HEAD

Makes changing calibers quick and simple. Leave the dies set up in the Turret Head and change the Head—one bolt does the trick! Six stations with standard 7/8"-14 threads.

Dies not included.

88902 TURRET HEAD

PRESS ACCESSORIES

PRO 2000® PRESS ACCESSORIES

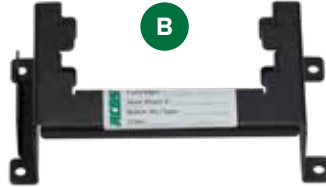
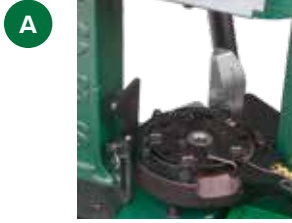

PRO 2000® PROGRESSIVE PRESS ACCESSORIES

- 88878 PRO 2000 STAR WHEEL (NOT PICTURED)
- 88877 PRO 2000 DIE PLATE (IMAGE C ABOVE)
- 86767 DUST COVER (NOT PICTURED)

C PRO 2000® DIE PLATE

Make caliber changes quickly and easily. Leave the reloading dies set up. Eliminates the need to install and adjust dies for each reloading session.

- 88877 PRO 2000 DIE PLATE

A PRO 2000® AUTO INDEX PRESS & UPGRADE KIT

The Upgrade Kit allows you to convert your manual indexing Pro 2000 to automatic indexing operation.

- 88883 AUTO INDEX UPGRADE KIT

D POW'R PUNCH DECAP ROD

For use with pistol calibers in Progressive Presses. The decap rod has a spring-loaded decapping pin to ensure the spent primer is always fully ejected from the primer pocket. Eliminates indexing problems with progressive presses caused by the spent primer jamming the shell plate. Works in all RCBS® pistol sizer dies. RCBS pistol sizing dies equipped with the Pow'r Punch Decap Rod Assembly will work in any brand progressive press that uses standard 7/8"-14 threaded dies.

- 9627 POW'R PUNCH DECAP ROD

B DIE PLATE/SHELL PLATE RACK

Keep your Pro 2000® die plates and five station shell plates organized. This handy rack can be mounted horizontally on your bench or vertically on the wall. The stamped steel rack securely holds your preset die plate and a side slot keeps the five station shell plate in place. An identification label is also included.

- 88881 DIE PLATE/SHELL PLATE RACK

CHAMBER/CARTRIDGE LENGTH GAUGES

E NEW

E CHAMBER/CARTRIDGE LENGTH GAUGES



RCBS Chamber/Cartridge gauges do double duty. Drop the handloaded round in to check both chambering as well as cartridge length. Limited Lifetime Warranty.

- 88270 9MM GAUGE
- 88271 .38 SPL GAUGE
- 88272 .40 S&W GAUGE
- 88273 .45 ACP GAUGE
- 88274 .45 COLT GAUGE
- 88280 .223 REM/5.56X45
- 88281 .308 WIN/7.62X51
- 88282 300 AAC BLACKOUT

PROGRESSIVE PRESS ACCESSORIES



F POWDER CHECKER

A simple, effective way to visually check powder charges when you use a progressive press. The Powder Checker sits between the powder charging and bullet seating stations. Using a probe rod, it lets you visually confirm that the case is properly charged with powder before bullet seating. In addition to spotting a “no-charge” condition, the Powder Checker shows low and high charges too. Black oxide finish provides contrast for better visibility. For use with straight-wall or bottleneck rifle and pistol cases, .22 caliber and larger.

87590 POWDER CHECKER

G LOCK-OUT DIE

The Lock-Out Die detects a “no powder” or a “double charge” condition in the progressive reloading process. It locks up, halting the travel of the ram, alerting the reloader to the problem so the cause can be corrected. Will not let you continue without removing the improperly charged cartridge. For use with straight-wall pistol calibers, 9mm and larger, and only on progressive reloading presses.

87540 LOCK-OUT DIE

H DIE LOCK-RING WRENCH

No more bashed knuckles or fumbling with adjustable wrenches. The RCBS® Die Lock-Ring Wrench simply slips onto the die lock ring for quick and easy adjustment. A pivoting handle allows leverage from any angle and the heat-treated steel stands up to all the brute force you can muster.

9634 DIE LOCK-RING WRENCH (1-3/16”)

I TUBE PISTOL BULLET FEEDER

These caliber specific tube fed Pistol Bullet feeders are designed to be used with any 7/8”-14 threaded progressive press. Each clear tube holds 20-25 bullets, depending on weight and profile. The Tube PBF places the bullet into the case mouth, for proper alignment, to be seated at the next station. Another added benefit is that it can be used with jacketed, plated, cast or swaged lead bullets. Increase load output up to 50%. Patent #8,707,845. Two bullet tubes are included with each unit, extra bullet tubes sold separately.

- Tube fed, allows use of jacketed, plated, cast or swaged lead bullets
- Compatible with any 7/8”-14 threaded press
- Increase load rate up to 50%
- RCBS Limited Lifetime Warranty

82355 TUBE PBF .380/9MM/.38-.357 (90-158-GRAIN)

82356 TUBE PBF .38/.357 (158-180-GRAIN)

82357 TUBE PBF .40 S&W/10MM

82358 TUBE PBF .45 ACP

82359 PBF TUBE .40/.45 (2 PACK)

82360 PBF TUBE .380/.357 MAGNUM (2 PACK)

J TUBE RIFLE BULLET FEEDER

The new RCBS Tube Rifle Bullet Feeder features the ability to feed most styles of rifle bullet. Designed for progressive reloading of .22 or .30 cal, expander die included. Limited Lifetime Warranty.

82361 TUBE RIFLE BULLET FEEDER - .22

82362 TUBE RIFLE BULLET FEEDER - .30 CAL

PRESS ACCESSORIES

PROGRESSIVE PRESS ACCESSORIES



K

Pro Chucker Press shown not included.

K PRO CHUCKER TUBE CASE FEEDER (PRO CHUCKER ONLY)

The Pro Chucker Tube Case Feeder installs on the RCBS Pro Chucker 5 or Pro Chucker 7 progressive press, converting it to an automated case feed for both Bottleneck and Straight Wall cases and can increase output by more than 25%. The model 88915 Tube Case Feeder includes a medium feed tube that accommodates 80% of the Pro Chucker case fits. The addition of the model 88916 SM/LG Feed Tubes allows the user to automatically feed cases for all Pro Chucker Shell Plate fits – but the user must have the 88915 to use the 88916. Other powered case collators and feeders can be adapted to feed the RCBS Pro Chucker Tube Case Feeder. The product comes with a Limited Lifetime Warranty.

88915 PRO CHUCKER TUBE CASE FEEDER
88916 SMALL & LARGE TUBE



L

Pro2000 Press shown not included.

L BULLET FEEDER—PISTOL KIT (PROGRESSIVE PRESS)

Designed to fit on most 7/8"-14 threaded progressive presses the RCBS® Pistol Bullet Feeder Kit features a four country universal 110-240 VAC operated collator unit that orients the bullets to drop into the feed mechanism. The hopper holds approximately 200 bullets. The kit contains adapters to load 9mm/.38 Special/.357 Mag., 10mm/.40 and .45 ACP jacketed/FMJ pistol bullets. Load rate increased by 50%. Patent #8,707,845. NOTE: Not for use with lead bullets. Use jacketed or FMJ bullets only.

- Hopper holds approximately 200 bullets
- Bullets are oriented to drop directly into feed mechanism
- Adaptors allow loading of 9mm/.38 Special/.357 Mag., 10mm/.40 & .45 ACP jacketed/FMJ pistol bullets
- RCBS two year warranty
- Plug adapters for U.S., U.K., AUS. and E.U. included with CE approved power supply
- Increase load rate by 50%
- Adjustable collator height

82351 BULLET FEED DIE—PISTOL

UNIVERSAL PRESS ACCESSORIES



M ACCESSORY PRESS BASE PLATE-3

Save time, space and eliminate a loading bench top full of holes. Simply attach the Accessory Base Plate—3 to any work surface, then use the pre-tapped, letter-coded holes to quickly mount or dismount RCBS® Pro Chucker 5, Pro Chucker 7, The Grand Shotshell, Rock Chucker Supreme, Summit, Trim Pro-2 Case Trimmers, Trim Pro®, Powder Measure Stand, Lube-A-Matic—2, Reloader Special, Rock Chucker®, Pro 2000®, Turret Press, AmmoMaster®, Partner Press and the APS® Bench Mounted and automatic priming tools. Fastening hardware included. Measures approximately 10" x 6" x 1".

9282 ACCESSORY BASE PLATE-3

M Equipment readily secures to plate for quick tool change-overs. Makes the most of limited bench space.

A



A

ROCK CHUCKER® SUPREME MASTER RELOADING KIT

We've taken the new benchmark of single stage presses and surrounded it with the equipment you need (except dies and shell holders) to start loading like a pro. A simple solution for the beginner and pro alike. All RCBS reloading kits have been updated to include the Universal Case Loading Block, .17-.60 Debur Tool and the Accessory Handle—2.

9354 ROCK CHUCKER SUPREME MASTER KIT

CONTENTS:

- Rock Chucker Supreme Press
- M500 Mechanical Scale
- Uniflow™ Powder Measure
- Hand Priming Tool
- Universal Case Load Block
- Accessory Handle -2
- .17-.60 Debur Tool
- Hex Key Set
- Case Lube Kit
- Powder Funnel
- Nosler Reloading Manual

B



B

TURRET DELUXE RELOADING KIT

With this kit you'll only need to add a Reloading Die Set and Shell Holder for the caliber(s) you intend to reload. Information on each individual kit component is described elsewhere in this catalog—see the index. Buy the kit and save about 10% of the price of each item separately. All RCBS reloading kits have been updated to include the Universal Case Loading Block, .17-.60 Debur Tool and the Accessory Handle—2.

88908 TURRET DELUXE RELOADING KIT

CONTENTS:

- Turret Press
- Uniflow™ Powder Measure
- M500 Mechanical Scale
- Nosler Reloading Manual
- Universal Case Load Block
- Accessory Handle -2
- Case Lube Kit
- Fold-up Hex Key Wrench Set
- Primer Tray—2
- .17-.60 Debur Tool
- Powder Funnel

C



C

AMMOMASTER® .50 BMG PACK

The AmmoMaster® .50 BMG Pack makes reloading for the .50 Browning Machine Gun cartridge a simple task. Manufactured to accept RCBS® 1-1/2" .50 BMG dies, along with the massive 1" solid steel ram, provides more than enough strength to handle the .50 and will provide a lifetime of service. This kit includes the press, Full-Length Sizer, Seater Die, Shell Holder, Ram Priming Unit and Trim Die in one convenient box. The only extras required are cartridge components and the rifle to fire them!

88700 AMMOMASTER .50 BMG PACK

88715 STANDARD SHELL HOLDER ADAPTOR

PRESS KITS



Accessory Base Plate shown not included.

D EXPLORER™ PLUS RELOADING KIT

RCBS® has compiled some of the most important tools and equipment reloaders need in two superb new kits. Both the Explorer and Explorer Plus include solid, reliable reloading tools, and each saves consumers more than \$100 over the cost of buying the items separately. *A portion of the proceeds go to support youth hunting and shooting programs.*

Accessory Base Plate not included.

9287 EXPLORER PLUS RELOADING KIT

CONTENTS:

- Reloader Special™-5 Press
- Uniflow™ Powder Measure
- 1,500-grain Digital Pocket Scale
- Nosler Reloading Manual
- Hand Priming Tool
- Universal Case Loading Block
- Debur Tool
- Powder Funnel
- Case Slick® Spray Lube
- Powder Trickler-2
- Advanced Powder Measure Stand
- Pow'r Pull® Kit
- Stainless Steel Dial Caliper
- Measure Cylinder (small)
- Six Die Lock Rings
- No. 2, 3, 4, 10 and 43 Shell Holders



Accessory Base Plate shown not included.

E EXPLORER™ RELOADING KIT

RCBS® has compiled some of the most important tools and equipment reloaders needed in two superb new kits. Both the Explorer and Explorer Plus include solid, reliable reloading tools, and each saves consumers more than \$100 over the cost of buying the items separately. *A portion of the proceeds go to support youth hunting and shooting programs.*

Accessory Base Plate not included.

9286 EXPLORER RELOADING KIT

CONTENTS:

- Reloader Special™-5 Press
- Uniflow™ Powder Measure
- 1,500-grain Digital Pocket Scale
- Nosler Reloading Manual
- Hand Priming Tool
- Universal Case Loading Block
- Debur Tool
- Powder Funnel
- Case Slick® Spray Lube
- Powder Trickler-2



F PARTNER RELOADING KIT

Our Partner™ Press anchors this excellent starter kit. Big on performance, small on price, the Partner is the ideal entry-level press. Here it's coupled with some of the finest "basic" reloading tools you'll find anywhere. All RCBS reloading kits include the Universal Case Loading Block, .17-.60 Debur Tool and the Accessory Handle—2.

87469 PARTNER PRESS RELOADING KIT

CONTENTS:

- Partner Press
- M500 Mechanical Scale
- Case Lube Pad
- Case Lube—2
- Universal Case Load Block
- Case Neck Brushes
- .17-.60 Debur Tool
- Accessory Handle—2
- Powder Funnel
- Nosler Reloading Manual



A



B



C



D



E

A PRECISION MIC™

A few twists of the Precision Mic™ and you'll know your chamber headspace and bullet seating depth to 0.001 of an inch. The Precision Mic measures from the datum point on the case shoulder to the base, giving you spot-on SAAMI tolerance readings. An indispensable tool for safe, accurate loads that extend the life of your rifle brass.

PRECISION MICS

.204 Ruger	88299	.270 WIN	88316
.22-250 Rem	88302	7mm Rem Mag	88319
.223 Rem	88304	7mm-08 Rem	88322
.243 Win	88305	.30-06 Spring	88324
6mm Rem	88306	.300 WSM	88325
.25-06	88307	.300 Win Mag	88327
.257 Roberts	88308	.300 RUM	88328
.260 Rem	88312	.308 Win	88329
6.5 Creedmoor	88313	.338 Win Mag	88331
6.5mm x 55	88314	.338 Lapua Mag	88332
.270 WSM	88315	.375 H&H Mag	88337

B ELECTRONIC DIGITAL MICROMETER

Instant reading. Top of the line. Enamelled metal body with matte finished, non-glare thimble. Outside micrometer has 0-1"/0-25mm range. Counter reads to .00005". Resolution .00005"/0.001mm. Accuracy .0001"/.0025mm. Large, easy to read numbers for error reduction with instant inch/millimeter conversion. Zero adjust at any position. Thimble lock for measuring like objects. Battery included. Auto off after five minutes for longer battery life. Fitted storage case. Imported.

87320 ELECTRONIC DIGITAL MICROMETER

C VERNIER BALL MICROMETER

Economical Vernier Ball Micrometer for measuring case neck thicknesses. All metal body and thimble with matte finish. Range: 0-1". Accuracy within .0001". Ratchet stop on thimble assures uniform application of pressure. Thimble lock keeps thimble from turning when measuring a constant. Adjustment wrench included. Fitted plastic storage case. Imported.

Accessory Base Plate not included.

87324 VERNIER BALL MICROMETER

D MECHANICAL DIGITAL MICROMETER

Quick, easy to read. Metal body with satin chrome thimble. White numbers on black background. Outside micrometer has 0-1" range. Mechanical counter reads to .001". Resolution: .0001". Accuracy within .0001". Ratchet stop on thimble applies even pressure for measuring. Thimble lock stops thimble from turning when measuring like objects. Adjustment wrench included. Fitted wooden storage case. Imported.

87322 MECHANICAL DIGITAL MICROMETER

E VERNIER MICROMETER

Economical version without the bells and whistles. All metal body and thimble with silver matte finish. Crisp black numbers and markings for easy reading. Range: 0-1". Reads to .0001 of an inch. Accuracy within .0001". Ratchet stop on thimble ensures uniform application of pressure when measuring. Thimble lock keeps thimble from turning when measuring a constant. Adjustment wrench included. Fitted plastic storage case. Imported.

87321 VERNIER MICROMETER

CASE PREP



F DIAL CALIPER/CASE LENGTH GAUGE

Fiberglass reinforced super polyimid construction. Range of 0-6"/0-150mm. Direct .001" readings. Graduations .001" increments with 0.100" per single revolution of dial; 1.0mm bar scale. Dial adjustable to zero. Four-way measurements: outside, inside, depth and step.

Comfortable friction thumb roller opens and closes caliper. Large, easy to read black numbers and markings on white background. Fitted clear plastic storage case. Imported.

87301 DIAL CALIPER/CASE LENGTH GAUGE

G STAINLESS STEEL DIAL CALIPER

Hardened stainless steel construction. Matte, non-glare finish. Range 0-6". 0.100" direct reading per revolution. 0.001" graduations. Accurate to +/- 0.001". Four-way measurement capability: inside, outside, depth and step. Shockproof movement for accurate measurements. Clear lens protects dial from dust and scratches.

Slide may be locked in any position with thumb lock. Dial easily zeroed. Lock screw holds dial in position for precise measurements. Thumb wheel makes for easy opening and closing of the caliper. Fitted hard plastic storage case. Imported.

87305 STAINLESS STEEL DIAL CALIPER

H ELECTRONIC DIGITAL CALIPER

Instant reading. Very easy to use. Hardened stainless steel body for prolonged tool life. Switches from inches to millimeters with the touch of a button. Range of 0-6"/0-150mm. Accuracy +/- 0.001"/0.02mm. Resolution: 0.0005"/0.01mm. Large, easy to read numbers, reduces error—no guessing. Adjusts to zero at any position. Measures internal, external, depth and step dimensions. Jaw depth measures 1-1/2" outside, 5/8" inside. Lock holds slide in position for measuring constants. Battery included. Low battery indicator. Fitted plastic storage case. Imported.

87323 ELECTRONIC DIGITAL CALIPER

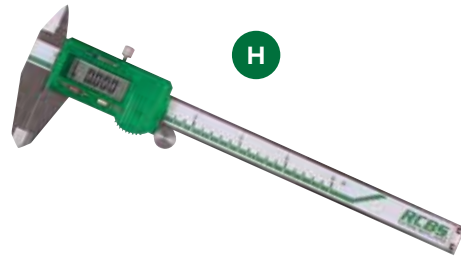
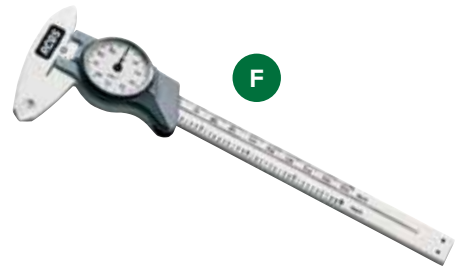

I CASE MASTER® GAUGING TOOL

A quick, convenient way to determine several important case and cartridge dimensions. The Case Master® gauging tool measures case neck concentricity, uniformity and thickness, as well as case length and bullet run-out. All are important to accuracy and safety. Detects case head separation before symptoms are apparent on the outside of case. Much quicker than a dial caliper and makes a tedious job simple and less tiring.

87310 CASE MASTER GAUGING TOOL



J 50 BMG HIGH CAPACITY CASE TRIMMER KIT

Trim all of your big bore cases in no time with the new RCBS® High Capacity Case Trimmer. Designed to handle the most beefy cases such as the .50 BMG and .416 Barrett—plus many other favorites—RCBS answers the call of the big bore shooter. Includes .408, .416 and .50R caliber pilots.

- 90352 HIGH CAPACITY CASE TRIMMER
- 90353 COLLET #1
- 90354 COLLET #2

HC COLLET FIT CHART

.50 BMG/.416 Barrett	HC #1	HC #2
.40-60 Winchester	.50-70 Gov't	.338 Lapua
.408 CheyTac	.50-90-21/2" Sharps Straight	.40-65 Shiloh Sharps
.416 Barrett	.56-50 Spencer	.45-70 Gov't
.45-60 Winchester	.470 NE 31/4"	.45-90-2.4" Sharps Straight
450x400x3" (400 Jeffery)	.500 Jeffery	.45-100-2.6" Sharps Straight
.50-95 Winchester	.500 NE 3"	.45-110-27/8" Sharps Straight
.505 Gibbs		.45-120-31/4" Sharps Straight
.50 BMG		.404 Jeffery
		.450 Rigby Rimless

K .50 BMG PRIMING SYSTEM

The RCBS® .50 BMG Priming system provides a dedicated bench mounted system that allows handloaders to easily reprime their cases. The primer tube holds (20) .50 BMG primers and features a Safety Shield Tube. Primer pick-up tube, flat and oval primer seat plugs included.

- 9560 .50 BMG PRIMING SYSTEM

L 1-1/2"–12 BULLET PULLER

The 1-1/2"–12 Bullet Puller is designed for use on the AmmoMaster®—2 or AmmoMaster .50 BMG pack press. Using the .416 or .50 BMG bullet puller collets (sold separately) allows the quick removal of bullets from loaded ammunition so that you can salvage your components.

- 9446 1-1/2"–12 BULLET PULLER
- 9447 .416 BARRETT COLLET
- 9448 .50 BMG COLLET

M .50 BMG CARBIDE PRIMER POCKET UNIFORMER

Designed to be used with the RCBS® Accessory Handle, Trim Mate Case Prep Center or the case prep part of the Universal Case Prep Center, the .50 BMG Carbide Primer Pocket Uniformer utilizes a carbide cutter to square the bottom of the primer pocket and uniform the primer pocket depth. This allows the handloader to easily seat primers to a consistent depth for reliable ignition.

- 9561 .50 BMG CARBIDE PRIMER POCKET UNIFORMER

N .50 BMG MILITARY CRIMP REMOVER

Designed for use with the RCBS® Accessory Handle, Trim Mate Case Prep Center or the case prep part of the Universal Case Prep Center, the .50 BMG Military Crimp Remover cuts away the primer pocket crimp found on military .50 BMG brass, allowing the handloader to easily reprime their cases.

- 9562 .50 BMG MILITARY CRIMP REMOVER

CASE PREP

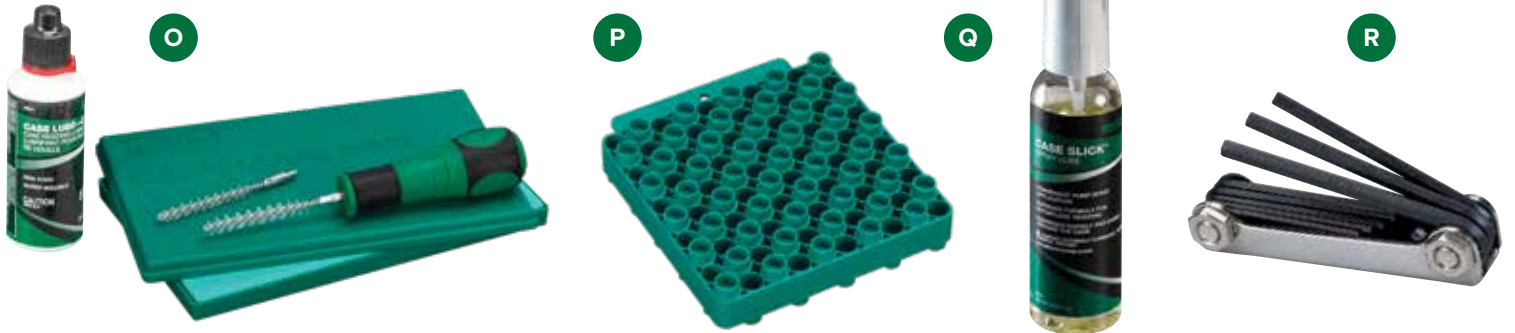

O CASE LUBE KIT

Properly clean and lube cases for resizing the simple way with this complete kit. Includes Case Lube Pad, 2-ounce bottle of Case Lube—2 and two interchangeable Case Neck Brushes for .22 through .30 calibers.

9336 CASE LUBE KIT

CASE LUBE—2 (PICTURED ABOVE WITH CASE LUBE KIT)

An excellent lubricant that's water soluble and convenient to wipe off easily with no sticky residue. Non-toxic. Use Case Lube—2 with RCBS® Lube Dies or Case Lube Pad.

9311 CASE LUBE—2 (2 OZ. BOTTLE)

CASE LUBE PAD (PICTURED ABOVE WITH CASE LUBE KIT)

The best way to lubricate cases for resizing or forming. Coat the pad with Case Lube—2, then roll the case lightly across it. Exactly the right amount of lubricant is transferred to the case. Pad is removable from sealable storage case for easy cleaning.

9307 CASE LUBE PAD

CASE NECK BRUSHES (PICTURED ABOVE WITH CASE LUBE KIT)

Clean dirt and powder residue from inside necks and simultaneously lubricate for expansion with our case neck brushes. The no-roll handle design accepts all three nylon bristle brushes: small brush for .22 to .25 caliber, medium brush for .270 to .30 caliber, large brush for .35 to .45 caliber.

9327 CASE NECK BRUSH-SMALL
9328 CASE NECK BRUSH-MEDIUM
9329 CASE NECK BRUSH-LARGE

P UNIVERSAL CASE LOADING BLOCK

The RCBS® Universal Case Loading Block has been designed to fit most any standard rifle or pistol case including the WSM, WSSM and Ultra Mag family of cartridges. The two-sided design offers three different case fits per side and will hold 50 cases. Short pistol cases fit in the raised upper portion of the block for easy access. The stepped holes accommodate large pistol and rifle cases.

9452 UNIVERSAL CASE LOADING BLOCK

Q CASE SLICK® SPRAY LUBE

Case Slick is an exclusive formulation that provides exceptional lubricity for resizing or forming of metallic rifle and pistol cases. Testing reveals Case Slick reduces the force needed to resize .308 Winchester cases by 35 to 70% when compared to other lubes. Reducing the resizing force makes the process easier on you and your brass. Case Slick is formulated to flow evenly over the surface of the brass. Uniform coverage makes resizing a breeze and eliminates the possibility of denting the shoulder of the case.

9315 CASE SLICK SPRAY LUBE

† Shipped UPS Ground only. No international sales.

R FOLD-UP HEX KEY WRENCH

Eight heat-treated hex keys fit most hex head screws on RCBS® equipment. Key sizes: 0.050", 1/16", 5/64", 3/32", 7/64", 1/8", 9/64" and 5/32". Handy and easy to locate on the bench when you need a hex key.

98975 FOLD-UP HEX KEY WRENCH

S



T



U



V



S

DECAP DIE

Use our Decapping dies to quickly remove primers from cases prior to cleaning. The Decap Die .22-.25 will handle most cases. The H.D. die is designed for use on military primer crimped cases larger than 27-caliber.

- 87580 DECAP DIE .22-25-CALIBER**
- 87585 H.D. DECAP DIE .27-45-CALIBER**
- 87575 DECAP UNIT .22-25-CALIBER**
- 87586 H.D. DECAP UNIT**

U

MILITARY/BERDAN DECAPPING TOOL

For efficient removal of Berdan primers, nothing beats our Berdan Decapping Tool. Decap 8mm Rimless, 6.5mm Mannlicher- Schoenauer, 11.7mm Rimmed and more. All functional parts are made of top-grade, heat-treated steel alloy for toughness. Comes with case holder and hex wrench.

- 9525 BERDAN DECAPPING TOOL**
- 9528 BERDAN DECAPPING PIN**

T

LUBE DIES

Decap and lube cases in one step with our exclusive Lube Die. Designed for progressive presses like the Pro Chucker, Pro 2000, Piggyback™ II, AmmoMaster®, and Auto 4x4, but works just fine in single-stage presses. Four sizes cover 45 popular calibers. It's faster and cleaner than a lube pad; easy to refill with lubricant (RCBS® Case Lube—2); standard 7/8"-14 thread. See Reference Chart on page 45-46.

- 87551 LUBE DIE # 1**
- 87552 LUBE DIE # 2**
- 87553 LUBE DIE # 3**
- 87554 LUBE DIE # 4**
- 87575 DECAP UNIT**

V

PRIMER POCKET BRUSH COMBO

A build-up of residue in primer pockets can cause misfires. A couple of twists with our Primer Pocket Brush and residue is easily cleaned out. Brushes have stainless bristles and interchangeable mounts for large and small primer pockets. Comes with a no-roll accessory handle.

- 9574 PRIMER POCKET BRUSH COMBO**
- 9578 SMALL BRUSH ONLY**
- 9577 LARGE BRUSH ONLY**
- 9332 ACCESSORY HANDLE—2**



CASE PREP



W PRIMER POCKET SWAGER - BENCH TOOL

This dedicated bench mounted Primer Pocket Swager Tool makes removal of primer pocket staking/crimp a simple task. Staked/crimped primer pockets can be found in more than just military ammunition. Due to the popularity of AR platform rifles, much of the commercial ammunition also has staked primer pockets. The rugged die cast aluminum base, hardened steel cam and foam padded grip handle require 35% less force than other tools to complete the job. A hardened steel rod supports the case from the inside allowing the case to float for perfect alignment with the hardened steel swager head. Rotate the case down into position and with a simple pull and push of the handle, the job is complete. Includes hardened steel small and large swaging heads and rods to accommodate cases 22-caliber and larger.

9474 PRIMER POCKET SWAGER – BENCH TOOL

X FLASH HOLE DEBURRING TOOL

Burrs left on the inside of the flash hole during manufacturing can cause erratic ignition. This handy tool automatically locates the hole and quickly removes the burr. A self-centering pilot collar with an adjustable stop allows quick alignment and prevents the removal of too much brass.

FLASH HOLE DEBURRING TOOL WITH CASE PILOT STOP

.22 CAL.	88145	7MM CAL.	88147
6MM CAL.	88146	.30 CAL.	88148

FLASH HOLE DEBURRING TOOL CASE PILOT STOP ONLY

.22 CAL.	88122	.34 CAL.	88131
6MM CAL.	88123	.35 CAL.	88133
.25 CAL.	88124	.36 CAL.	88134
6.5MM CAL.	88125	.375 CAL.	88135
.270 CAL.	88126	40/10MM	88136
7MM CAL.	88127	.41 CAL.	88137
.30 CAL.	88128	.44 CAL.	88138
.32 CAL.	88129	.45 CAL.	88139
8MM CAL.	88130		

88144 REPLACEMENT ROD & CUTTER



Y PRIMER POCKET SWAGER COMBO—2

The Primer Pocket Swager has been redesigned to fit a larger group of cases. The swaging rods are made from stronger high tensile steel, more than doubling the strength of the original design.

NOTE: Not for use on progressive presses.

9481 PRIMER POCKET SWAGER COMBO—2

Z VLD DEBURRING TOOL

The increasing popularity of VLD style bullets has led RCBS® to offer a 22 degree VLD Debur tool. The 22 degree angle allows the bullet to be seated into the case without damaging the boat-tail and ruining accuracy. The VLD debur tool can be used as is, attached to a RCBS Accessory Handle or mounted on the Trim Mate Case Prep Center.

9352 VLD DEBURRING TOOL W/ HANDLE

9351 VLD DEBURRING TOOL

AA ACCESSORY HANDLE—2

Larger ergonomic handle for use with many RCBS accessories.

9332 ACCESSORY HANDLE—2

BB DEBURRING TOOL .17-.60

The larger Deburring Tool allows the inside and outside chamfering and deburring of cases from 17-caliber up to 60-caliber. Larger than our standard deburring tool, this tool is perfect for handloading cases over 45-caliber. But if you want one deburring tool to do it all, this is it. Made of hardened steel to last a lifetime.

9348 DEBURRING TOOL .17-.60



CC POW'R PULL® KIT

Get yourself out a jam with the RCBS® Pow'r Pull® Kit. This kinetic style bullet puller's rugged one-piece body and user-friendly ergonomic handle resolves mistakes quickly and easily. The three case holding chucks will accommodate cases from 5.7x28mm and .22 Hornet up through the WSM and RUM family of cartridges.

NOTE: Not for use with rimfire cartridges.

- 9412 POW'R PULL KIT
- 9451 REPLACEMENT SMALL CHUCK ASSEMBLY
- 9418 REPLACEMENT CHUCK ASSEMBLY
- 9416 MAGNUM CHUCK ASSEMBLY (FOR WSM & BELTED MAGS)

DD STANDARD BULLET PULLER

Not sure about the powder charge? Need to change bullets? The RCBS® Standard Bullet Puller is designed to easily pull and not damage jacketed bullets. It utilizes the standard 7/8"-14 thread and may be used in most single stage presses having this thread. Requires caliber specific collet listed below:

NOTE: Not for use with rimfire cartridges. Not for use with RCBS Summit press.

9440 STANDARD BULLET PULLER W/O COLLET

STANDARD BULLET PULLER COLLETS:

9419	.17	9429	.348
9438	.20	9430	.35/.38 Spec.
9420	.22	9437	9.3mm
9421	6mm	9431	.375
9422	.25	9432	.40
9423	6.5mm	9433	.41
9424	.270	9434	.416
9425	7mm	9435	.44/11mm
9426	.30/7.35mm	9436	.45
9427	.338	9439	.475
9428	.32/8mm	9445	.500

EE ULTRASONIC CASE CLEANER

Save time and get reloading faster with the RCBS® Ultrasonic Case Cleaner. Its 3.2-quart stainless steel tank holds a huge volume of brass cases, rapidly removing tarnish, carbon buildup and metal oxides. Use the keypad and display to select one of five preset temperature settings and set the timer from 1 to 30 minutes to match your case-cleaning needs. Use with RCBS Ultrasonic Case Cleaning Solution (sold separately) for perfect results every time. It features a powerful 60W transducer, 100W ceramic heater, 36kHz ultrasonic frequency and a sensor that indicates when to change out solution. The cleaner has a degas function, plastic basket, and convenient drain valve and tube.

87055 ULTRASONIC CASE CLEANER 120 VAC US/CAN

FF ULTRASONIC CASE CLEANER -2

The new RCBS® Ultrasonic Case Cleaner -2 includes significant changes from the previous model. The Ultrasonic Case Cleaner -2 is larger – nearly 100% larger. The 6.3-quart capacity is twice as big, with a second ceramic heater and transducer to better clean brass cases and firearm parts. The LCD is easily programmable, and the timer can be set for up to 30 minutes of continuous cleaning. The Ultrasonic Case Cleaner -2 delivers clean brass in a short amount of time.

87056 ULTRASONIC CASE CLEANER -2 120 VAC US/CAN

87061 ULTRASONIC CASE CLEANER -2 240 VAC INTERNATIONAL

GG ULTRASONIC/ROTARY CASE CLEANING SOLUTION

Designed for use with the RCBS® Ultrasonic Case Cleaner, the Ultrasonic/Rotary Case Cleaning Solution quickly removes tarnish, carbon buildup and metal oxides from cartridge cases. The specialized formulation cleans brass cases inside and out, including the primer pockets (spent primers must be removed), producing a bright, professional-grade finish. Ultrasonic/Rotary Case Cleaning Solution is non-corrosive and non-combustible, making it safe and easy to use. One quart of the concentrated solution makes 10 gallons of cleaning mix, and it comes with a built-in measuring cup for use with all brands of ultrasonic cleaners. The Ultrasonic/Rotary Concentrate Solution has anti-tarnish protection and works with rotary style cleaners.

87057 ULTRASONIC/ROTARY CONCENTRATE

CASE PREP



HH ULTRASONIC WEAPONS CLEANING SOLUTION

Designed for use with the RCBS® Ultrasonic Case Cleaner, Ultrasonic Weapons Cleaning Solution quickly removes grease, carbon buildup and fouling from firearm parts and reloading dies. The fast-acting synthetic detergent cleans all part surfaces, and its rust preventive helps stop corrosion. Ultrasonic Weapons Cleaning Solution is easy to use, and its formulation is non-corrosive and non-combustible.

CONTENTS

- 1-quart container makes 10 gallons of cleaning mix (40:1 ratio)
- Built-in measuring cup
- Made in the USA

87059 ULTRASONIC WEAPONS CLEANING SOLUTION

II CASE CLEANING MEDIA

Our dry media can be used in both Sidewinder and Vibratory Case Cleaners. Formula 1 Walnut Shell is ground to a 12/12 sieve size. Formula 2 is Corn Cob. Polish comes individually packed so you can choose various amounts of media to mix.

87067 FORMULA 1 WALNUT SHELL DRY MEDIA

87068 FORMULA 2 CORN COB DRY MEDIA

87069 POLISHING COMPOUND (5-PACK)

JJ VIBRATORY CASE POLISHER

Bright, ready-to-load brass is ready in minutes with the RCBS® Vibratory Case Polisher. It shines up to 14 pounds of brass/media at one time with aggressive vibrating action. A quiet motor powers the cleaner, and a sifting lid helps separate brass from debris. Quality handloads start with quality brass, and the Vibratory Case Polisher delivers.

87060 VIBRATORY CASE POLISHER 120 VAC US/CAN

87065 VIBRATORY CASE POLISHER 240 VAC INTERNATIONAL

KK ROTARY CASE CLEANER

The RCBS® Rotary Case Cleaner thoroughly cleans cases with constant rotating action. The quiet, gear-driven motor rotates the drum at 60 RPM. The tumbling action scrubs all surfaces of the cartridge case, inside and out, and the timer can be set for up to three hours of consecutive cleaning. The quiet, rubber-lined drum features an ergonomic handle for easy loading and unloading, and the quick-locking lid keeps contents secure.

CONTENTS

- Includes five pounds of magnetic stainless steel media
- 240 VAC model is EU/UK/AUS compliant
- Limited Two Year Warranty

87001 ROTARY CASE CLEANER 120 VAC US/CAN

87006 ROTARY CASE CLEANER 240 VAC INTERNATIONAL

87002 REPLACEMENT DRUM

LL CASE MEDIA SIFTER

Quickly and easily separate the cleaning media from the cleaned cases. First dump the cleaned cases and media into a bucket. Next attach the Media Sifter to the Vibratory Case Cleaner and turn on the cleaner. Slowly pour the cases and media into the media sifter. Allow the Case Cleaner to run until all the media is emptied back into the bowl—then it's ready for the next time cases need cleaning.

87075 CASE MEDIA SIFTER

MM ROTARY CASE/MEDIA SEPARATOR

In short order, separate the cleaned cases from the cleaning media. Merely empty the cases and media from the case cleaner into the separator basket. With several turns of the basket handle the media falls to the bottom of the separator, leaving the cases clean and ready to use. The fine dust from the media is trapped inside the separator. Heavy-duty plastic construction for years of trouble-free service. Capacity: approximately 180 .30-06 cases or 400 .38 Special cases with media.

87076 ROTARY CASE/MEDIA SEPARATOR



Hand Case Neck Turner Pilot



Pilot/Neck Reamer

NN HAND CASE NECK TURNER

The RCBS® Hand Case Neck Turner is designed to “peel” the brass from the outside of your case necks to a consistent thickness. Most commercially available brass has variances in the case neck thickness. This leads to case neck concentricity and bullet run-out issues. Truing up the case neck produces more consistent and accurate hand loaded ammunition. The cutter portion uses caliber specific pilot/mandrels (sold separately) to guide the case neck.

The cutter design features the ability to “zero” the cutter to the pilot/mandrel and then use the micrometer adjustment to dial the desired case neck thickness in .0005” increments. The cutter can also be set for right or left handed use.

The Quick Change Case Holder has many advantages over the competition. Most other units use a “tap wrench” design to hold cartridge cases. Though this is great for threading holes with a self feeding tap, it does nothing to feed your case neck to the cutter. The RCBS Quick Change Case Holder features an ergonomic design that allows you to rotate the case and put forward pressure to feed the case neck to the cutter. The quick case change feature helps to speed up the process without having to use small obtrusive thumbscrews.

- 90401 HAND CASE NECK TURNER W/ QC CASE HOLDER**
- 90402 QUICK CHANGE CASE HOLDER**
- 90405-27 HAND CNT PILOT .17-.500**

OO HAND CASE NECK TURNER PILOTS

HAND CASE NECK TURNER PILOTS:

90405 .17 Cal.	90413 .30 Cal.	90421 .40 Cal.
90406 .20 Cal.	90414 .31 Cal.	90422 .41 Cal.
90407 .22 Cal.	90415 .32 Cal.	90423 .416 Cal.
90408 .24 Cal.	90416 .33 Cal.	90424 .44 Cal.
90409 .25 Cal.	90417 .34 Cal.	90425 .45 Cal.
90410 .26 Cal.	90418 .35 Cal.	90426 .475 Cal.
90411 .27 Cal.	90419 .36 Cal.	90427 .500 Cal.
90412 .28 Cal./7mm	90420 .37 Cal.	

PP CASE NECK TURNING ACCESSORIES

Two tools for fast, easy removal of excessive neck thickness or variation in case thickness. They guide the cutter over the sized cartridge case neck and are supported by the special pilot/reamer. The inside and outside of the neck are turned simultaneously. The Auto Feed Attachment (for Case Trimmer-2, Trim Pro and Trim Pro-2 Manual Case Trimmer) advances the cutting tool evenly over the case neck with each turn of the trimmer handle.

NOTE: Not to be used with Trim Pro or Trim Pro -2 Power Case Trimmer.

- 98860 CASE NECK TURNER W/ AUTO FEED**
- 98861 CASE NECK TURNER**

QQ PILOT/NECK REAMERS

PILOT/NECK REAMERS:

98877 .17 Cal.	98883 7mm Cal.
98876 .20 Cal.	98884 .30 Cal.
98878 .223 Cal.	98886 8mm Cal.
98879 .6mm/243 Cal.	98887 .338 Cal.
98880 .25 Cal.	98889 .35 Cal.
98881 6.5mm Cal.	98891 .375 Cal.
98882 .270 Cal.	

CASE TRIM

A



NEW

B



A

BRASS BOSS

Getting brass ready to reload used to be a long, arduous process. No more. The RCBS Brass Boss features six variable speed, rotating stations that completely prepare trimmed brass for reloading, all in one stop. The Brass Boss includes tools for all six stations: an inside VLD chamfering tool, outside deburring tool, primer pocket cleaner (small/large), military crimp remover (small/large), primer pocket uniformer (small/large), case neck brushes (four diameters) and a tub of dry case neck lubricant. Save time, elbow grease and process brass efficiently with Brass Boss.

- Six variable, high-speed rotating stations (four at <350 rpm; two at <550 rpm)
- Two fixed stations for case neck brushes
- Tools included for all stations
- Storage area for tools not in use
- 120-240 VAC for operation in multiple countries
- US, UK, EU and Australian power cords
- 2-year limited warranty

90390 BRASS BOSS 120/240 VAC MULTI COUNTRY

B

UNIVERSAL CASE PREP CENTER

The Universal Case Prep Center is powered by a 24-VDC motor that provides 9 inch-pounds of torque. Reloaders can also adjust the output shaft's RPM. There are six stations for case preparation; four offer up to 360 RPM, and two provide up to 550 RPM. The spring-loaded feed system offers hands-free trimming, and a single lever loads and unloads cases, then disengages them from the cutter. It has an ambidextrous design and the spring loaded shell holder accommodates case head diameters from .250 to .625 inch, and lengths from .720 inch to 3.375 inches. Micrometer adjustment allows for fast, precise cuts. A shell holder carrier assembly makes adjusting trim length quick and easy. The Universal Case Prep Center includes primer pocket brushes, chamfer and debur tools, and alignment gauge, and it carries a two-year limited warranty.

Includes: .22, .24, .25, .27, .28, .30, .35, .44 and .45 pilots; large and small primer pocket brushes; and inside chamfer, outside debur and alignment tools.

90370 UNIVERSAL CASE PREP CENTER 120 VAC US/CAN

C



The Trim Pro Power Case Trimmer is better than having a personal lathe for case trimming.

D



C

TRIM PRO® POWER CASE TRIMMER

A low RPM motor delivers plenty of torque. The spring-fed cutter is easy and accurate. No pushing or feeding pressure is needed, leaving your hands free for deburring or other tasks. A positive locking handle and integral power switch makes it simple and safe.

Includes: Shell holders 2, 3, 4 and 10. Pilot calibers: .22, .24, .25, .27, .28, .30, .35, .44 & .45. Two year limited warranty.

9406 CASE TRIMMER CUTTER

D

TRIM PRO® CASE TRIMMER STAND

Raise your manual case trimmer to new heights with the Trim Pro® Stand. Provides more working room and hand clearance. Also provides convenient storage space for Trim Pro Shell Holders and Pilots. Stand mounts easily on accessory base plate or directly on a bench. Dimensions: 4-7/8" x 8-5/8" x 1". Manual trimmers only.

NOTE: Pilots and shell holders not included.

90360 TRIM PRO CASE TRIMMER STAND

TRIM PRO® ACCESSORIES (NOT PICTURED)

Accessories for the Trim Pro® Power Case Trimmer.

90359 POWER UNIT ONLY 120 VAC US/CAN

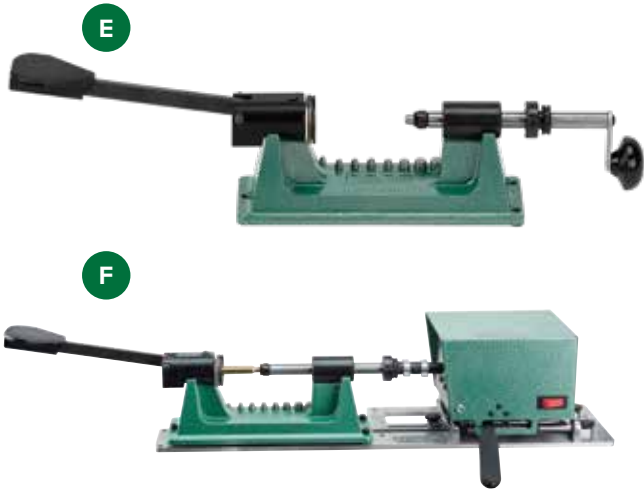

E TRIM PRO®-2 MANUAL CASE TRIMMER

The popular Trim Pro® case trimmer has been improved with the addition of a spring-loaded universal shell holder. The spring-loaded shell holder securely locks the case in alignment with the cutter. The trimmer is designed for .001" accuracy. Coarse and fine trim length adjustments. Fine adjustment bushing features .001" micrometer markings. The spring-loaded shell holder will accommodate case head diameters from .250" to .625" rims. Case fit is from the 5.7mmx28 to the long range .338 Lapua Magnum.

Kit includes pilots: .22, .24, .25, .27, .28, .30, .35, .44 and .45.

Note: Cases with rim diameters larger than .625" must be trimmed on the 90352 High Capacity Trimmer.

- 90365 TRIM PRO-2 MANUAL CASE TRIMMER (W/OUT PILOTS)
- 90366 TRIM PRO-2 MANUAL CASE TRIMMER KIT
- 86883 DUST COVER (NOT PICTURED)
- 98930 POWER DRILL CONVERTER
- 90250 REPLACEMENT CARBIDE TRIMMER CUTTER HEAD
- 9364 REPLACEMENT .50 CAL. TRIMMER CUTTER

.50R PILOT/50-CALIBER CUTTER (NOT PICTURED)

Pilots and cutter for use on Rotary or Trim Pro case trimmers. These accessories are a must if you are trimming cases like the .500 S&W or .50-90 Government.

- 9400 .50R PILOT
- 9364 50-CALIBER TRIMMER CUTTER

F TRIM PRO®-2 POWER CASE TRIMMER

Having the same improved spring-loaded universal shell holder of the manual trimmer, the Power Case Trimmer features a high torque low RPM motor. The self-feeding spring-fed cutter makes case trimming easy and accurate. No pushing or feeding pressure is required, leaving your hands free to do other case preparation tasks such as chamfering, deburring or primer pocket cleaning. The positive locking handle and integral power switch makes operation simple and safe. RCBS has also added a manual on/off switch to aid in setting case trim length. Two year limited warranty.

Kit includes pilots: .22, .24, .25, .27, .28, .30, .35, .44 and .45.

Note: Cases with rim diameters larger than .625" must be trimmed on the 90352 High Capacity Trimmer.

- 90367 TRIM PRO-2 POWER CASE TRIMMER KIT 120 VAC US/CAN



G TRIM PRO®-2 SHELL HOLDER CONVERSION

Upgrade your Trim Pro trimmer to eliminate the need to purchase additional TP Shell Holders. This conversion features spring-loaded jaws that will accommodate cases from .250" to .625". Not for use with Rotary Case Trimmer or Rotary Case Trimmer-2.

NOTE: Cases with rim diameters larger than .625" must be trimmed on the 90352 High Capacity Trimmer.

- 90368 TRIM PRO-2 SPRING LOADED SHELL HOLDER CONVERSION

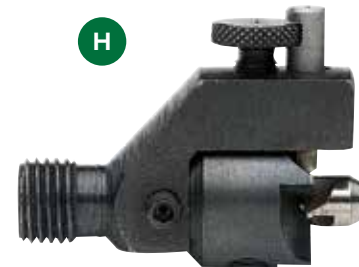

H TRIM PRO® 3-WAY CUTTER

This is automated case preparation at its finest. Our 3-Way Cutter is one of those accessories you can't live without. Its unique three-blade head configuration trims cases like our standard cutting tool, but in addition to trimming to length, inside blades chamfer the case while an outside blade deburrs it. The 3-Way cutter attaches easily to both Case Trimmers and Trim Pros.

- 90251 REPLACEMENT 3-WAY CARBIDE CUTTER HEAD

Note: Not for .17 to .20 caliber.

- 90245 VLD 3-WAY CARBIDE CUTTER

TRIM PRO 3-WAY CUTTERS: (INCLUDES CUTTER & PILOT)

90276	.17 Cal.	90282	.270 Cal.
90277	.20 Cal.	90283	7mm Cal.
90278	.22 Cal.	90284	.30 Cal.
90279	6mm Cal.	90285	.32 Cal.
90280	.25 Cal.	90287	.338 Cal.
90281	6.5mm Cal.	90291	.375 Cal.

TRIM PRO 3-WAY PILOT/CHAMFER

90256	.17 Cal.	90262	.270 Cal.
90257	.20 Cal.	90263	7mm Cal.
90258	.22 Cal.	90264	.30 Cal.
90259	6mm Cal.	90265	.32 Cal.
90260	.25 Cal.	90267	.338 Cal.
90261	6.5mm Cal.	90271	.375 Cal.

NEW



- 90245 VLD 3-WAY CARBIDE CUTTER

CASE TRIM

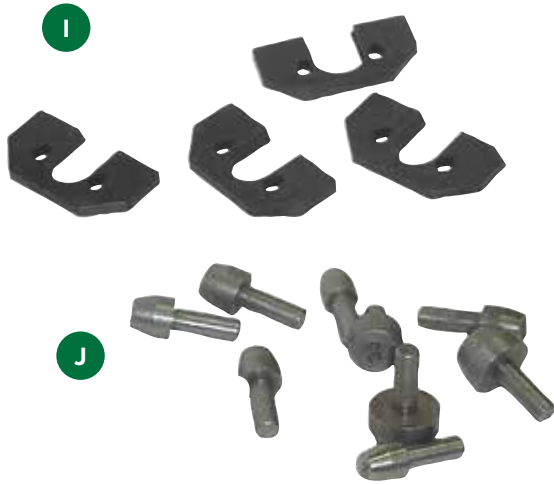

I TRIM PRO® SHELL HOLDER

The RCBS® Trim Pro® Case Trimmers feature unique shaped shell holders to firmly hold your rifle and pistol cases in perfect alignment with the cutter. This system allows for accurate and repeatable case trimming lengths and leaves the case mouths square to the body. The Trim Pro Shell Holders are numbered the same as our standard shell holders to make identification and use simpler. Available individually, or in pre-packs, for most popular rifle and pistol cartridges.

See the Reference Chart on pages 40-41 to determine the Trim Pro Shell Holder number required.

TRIM PRO SHELL HOLDERS			
90301	#1	90312	#12
90302	#2	90313	#13
90303	#3	90314	#14
90304	#4	90315	#15
90305	#5	90316	#16
90306	#6	90317	#17
90307	#7	90318	#18
90308	#8	90319	#19
90309	#9	90320	#20
90310	#10	90321	#21
90311	#11	9323	#23
		90324	#24
		90325	#25
		90326	#26
		90327	#27
		90328	#28
		90330	#30
		90332	#32
		90333	#33
		90334	#34
		90335	#35
		90336	#36
		90337	#37
		90338	#38
		90339	#39
		90340	#40
		90341	#41
		90342	#42
		90343	#43
		90344	#44
		90348	#48

J CASE TRIMMER PILOTS

Designed with a taper to guide pilot into the case mouth. Prevents case from wobbling when trimming case to length. Refer to the reference chart on page 25 to determine the correct pilot for a specific caliber. For use with RCBS® Trim Pro® Case Trimmers, Rotary Case Trimmer—2 and Rotary Case Trimmer.

For use with RCBS Case Trimmers only (See chart below)

See the Reference Chart on pages 40-41 to determine the Trim Pro Shell Holder number required.

CASE TRIMMER PILOTS			
9377	.17 Cal.	9388	.34 Cal.
9376	.20 Cal.	9389	.35 Cal.
9378	.22 Cal.	9390	.36 Cal.
9379	.24 Cal.	9391	.37 Cal.
9380	.25 Cal.	9392	.40 Cal.
9381	.26 Cal.	9393	.41 Cal.
9382	.27 Cal.	9397	.416 Cal.
9383	.28 Cal.	9394	.44 Cal.
9384	.30 Cal.	9395	.45 Cal.
9385	.31 Cal.	9396	.45-R Cal.
9386	.32 Cal.	9398	.475 Cal.
9387	.33 Cal.	9399	.500 Cal.
		9400	.50-R Cal.

TRIM PRO PISTOL PACK 90361	
CT Pilot, 40 Caliber	
CT Shell Holder #6	
CT Shell Holder #16	
CT Shell Holder #18	
CT Shell Holder #27	
TRIM PRO RIFLE PACK 90362	
CT Shell Holder #2	
CT Shell Holder #3	
CT Shell Holder #4	
CT Shell Holder #10	



K TRIM MATE™ CASE PREP CENTER & ACCESSORIES

Case preparation is five times easier and faster with the Trim Mate™ Case Prep Center. Five gear-driven rotating heads turn the tedious task of chamfering, deburring, primer pocket cleaning, military crimp removal and flash hole deburring into child's play. Works great with the Trim Pro®-2 Power Case Trimmer so you can do case prep and trimming at the same time. Two stationary positions hold case neck brushes, and a cupped area holds dry case neck lube. The Prep Center includes large and small primer pocket brushes, inside chamfering and outside deburring tools, medium and small case neck brushes and a packet of dry case neck lube. Two year limited warranty.

Accessories such as Primer Pocket uniformers are manufactured with carbide cutters, and true the primer pocket wall and bottom. Military Crimp Removers are made with hardened steel cutters and ream out the crimp ring found in military cases.

Note: Flash Hole Deburring Tool found on page 22.

- 90375 TRIM MATE CENTER 120 VAC US/CAN
- 90377 DRY CASE NECK LUBE
- 90378 PRIMER POCKET UNIFORMER, LARGE RIFLE - CARBIDE
- 90383 PRIMER POCKET UNIFORMER, LARGE PISTOL - CARBIDE
- 90379 PRIMER POCKET UNIFORMER, SMALL - CARBIDE
- 90382 DUST COVER
- 9351 VLD DEBURRING TOOL
- 9561 .50 BMG CARBIDE PRIMER POCKET UNIFORMER
- 9562 .50 BMG MILITARY CRIMP REMOVER
- 90384 TM CARBIDE CHAMFER TOOL
- 90385 TM CARBIDE DEBUR TOOL
- 90386 TM MILITARY CRIMP REMOVER—2, SMALL
- 90387 TM MILITARY CRIMP REMOVER—2, LARGE

TRIM PRO PILOT & SHELL HOLDER 90363	
CT Pilot 22 Cal.	
CT Pilot 24 Cal.	
CT Pilot 25 Cal.	
CT Pilot 27 Cal.	
CT Pilot 28 Cal.	
CT Pilot 30 Cal.	
CT Pilot 35 Cal.	
CT Pilot 44 Cal.	
CT Pilot 45 Cal.	
CT Shell Holder #2	
CT Shell Holder #3	
CT Shell Holder #4	
CT Shell Holder #10	



Primer tray is easily removed for loading and can accommodate 100 primers



A UNIVERSAL HAND PRIMING TOOL

The Universal Hand Priming tool combines features found on our other two hand priming tools into one convenient package. We took the universal shell holder from the APS® tool and combined it with the primer tray from the standard tool to offer unmatched performance. The universal shell holder will accept cases from .32 ACP to .45-70 Government. The removable primer tray orients your primers for use and will fit any manufacturer's primer packaging. Includes accessories to seat large and small rifle or pistol primers.

90201 UNIVERSAL HAND PRIMING TOOL

Primer tray is easily removed for loading and can accommodate 100 primers



B HAND PRIMING TOOL

Our Hand Priming Tool seats primers quickly. Fits in your hand for portable primer seating. Primer tray installation requires no contact with the primers. Uses the same RCBS® shell holders (post-1980) as RCBS presses. Made of durable cast metal. Includes large and small primer plugs.

90200 HAND PRIMING TOOL

90202 UHPT TRAY & LID ASSEMBLY

(UNIVERSAL HPT SQUARE TRAY & LID COMPATIBLE WITH 90200 HPT)

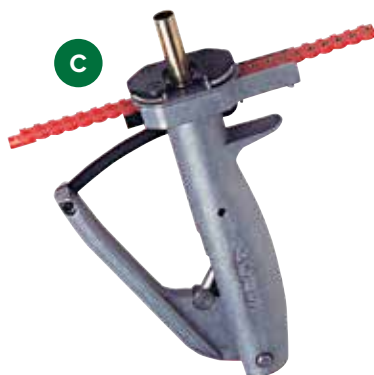

C APS® HAND PRIMING TOOL

It's fast and simple. The APS® Hand Priming Tool is simply revolutionary! First, the Universal Shell Holder completely eliminates the need for additional shell holders, accepting case sizes from .32 ACP to .45-70 Government. Secondly, each strip is color-coded for easy identification and holds up to 25 primers. The primer strips are even designed to connect to each other for continuous feed. Now, there's no need to handle loose primers or worry about contamination.

The APS Hand Priming Tool is also completely portable. You're no longer tied down to your bench to prime. Hand priming has never been easier, safer or more convenient!

88507 APS HAND PRIMING TOOL

PRIMING

Strips automatically feed and can be interlocked for uninterrupted priming

Uses standard RCBS Shell Holders and incorporates a fully adjustable seating depth

Machined from high-quality aluminum and comes with large and small primer rods

Adjustable handle provides excellent leverage and sensitive feel

D

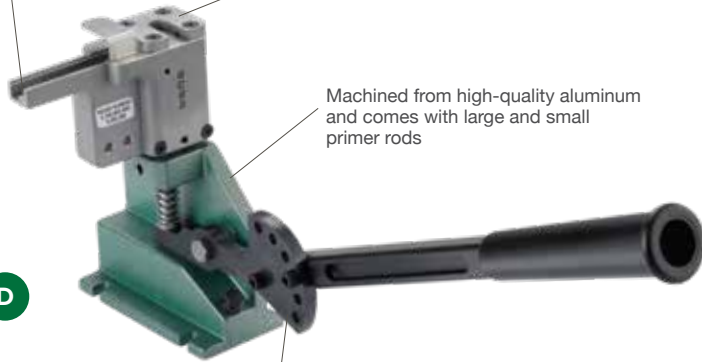

D APS® BENCH-MOUNTED PRIMING TOOL

The APS® Bench-Mounted Priming Tool was created for those reloaders who prefer to have a separate, specialized tool dedicated just for priming. It's a tool with exceptional feel for precise and consistent seating of primers. The handle on the bench-mounted tool is large by design to provide hours of comfortable loading. Handle position is adjustable for bench height or personal preference.

88501 APS BENCH-MOUNTED PRIMING TOOL

E APS® PRIMER STRIP LOADER

For those of you who may already have a supply of CCI® or Federal® primers or any other brands in conventional packaging, not to worry. The APS® Primer Strip Loader allows you to quickly fill empty primer strips. It's simple to use and even faster than loading a primer tube! Each push of the handle safely inserts 25 primers into an APS strip for use with the RCBS® APS Priming System.

88505 APS PRIMER STRIP LOADER



E

F

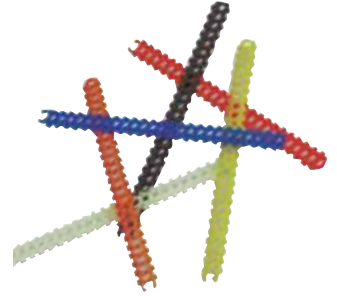

G

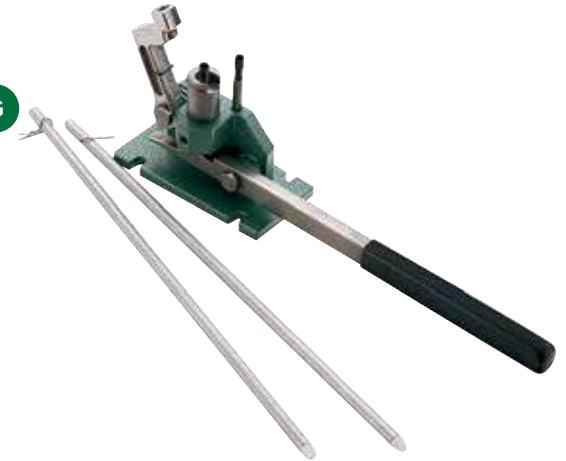

F APS® UNPRIMED PRIMER STRIPS

These strips are color-coded for fool-proof identification. Each strip holds 25 primers. Strips can be loaded with the primer of your choice using the striploader. Primers not included.

88510 APS STRIP, LG. RIFLE 8/PK	YELLOW
88511 APS STRIP, LG. PISTOL 8/PK	WHITE
88512 APS STRIP, SM. RIFLE 8/PK	YELLOW
88513 APS STRIP, SM. PISTOL 8/PK	WHITE
88514 APS STRIP, MAG LG. RIFLE 8/PK	BLUE
88515 APS STRIP, MAG LG. PISTOL 8/PK	RED
88516 APS STRIP, MAG SM. RIFLE 8/PK	BLUE
88517 APS STRIP, MAG SM. PISTOL 8/PK	RED
88518 APS STRIP, BR2 LG. RIFLE 8/PK	BLACK
88519 APS STRIP, BR4 SM. RIFLE 8/PK	BLACK
88520 APS STRIP, 5.56MM MILITARY 8/PK	ORANGE
88521 APS STRIP, 7.62MM MILITARY 8/PK	ORANGE

G AUTOMATIC PRIMING TOOL

The Automatic Priming Tool is fast, accurate and highly sensitive due to a unique single-stage lever system. Primers feed through the auto primer feed tube one by one, preventing potential contamination by oily fingers. Two primer rod assemblies and two primer feed tubes are included.

9460 AUTOMATIC PRIMING TOOL
9471 RAM PRIME PRIMER ROD ASSEMBLY



H AUTOMATIC PRIMER FEED COMBO

Drops primers one at a time into the Primer Plug and sleeve. Stops misfires as greasy fingers never need to touch primers. Nylon Primer Pick-up keeps primers from falling out. Tube capacity: 100 primers.

For Rock Chucker® II Press; also fits JR and Reloader Special Presses.

NOTE: Not for use with RC Supreme.

- 9580 AUTO PRIMER FEED COMBO FOR LARGE & SMALL PRIMERS
- 9581 LARGE PRIMER TUBE ONLY
- 9582 SMALL PRIMER TUBE ONLY

K UNIVERSAL PRIMER ARM—2

Designed for fast, accurate primer seating. Primer plugs and sleeves included for large and small rifle and pistol primers. Changing sizes is fast and easy—less than 60 seconds. Fits Rock Chucker® II, JR, Reloader Special and most “C” Presses.

NOTE: Not for use with RC Supreme

- 9550 UNIVERSAL PRIMER ARM FOR LARGE & SMALL PRIMERS
- 9552 PRIMER PLUG, SLEEVE & SPRING FOR LARGE PRIMERS
- 9553 PRIMER PLUG, SLEEVE & SPRING FOR SMALL PRIMERS

I RAM PRIMING UNIT

The Ram Priming Unit gives you better “feel” by seating the primer at the top of the press stroke. You can also preset a positive stop to speed up your reloading process. Works with any single stage or turret press with 7/8”-14 thread and RCBS-type single stage shell holder. Includes large and small primer rod assemblies for Boxer-type rifle and pistol primers.

- 9165 RAM PRIMING UNIT

J .50 BMG RAM PRIMING UNIT

The .50 BMG Ram Priming Unit in conjunction with the AmmoMaster® Single Stage press allows you to re-prime this powerful cartridge. It comes supplied with a flat and cupped primer plug to accommodate the two styles of primers available for the .50 BMG.

- 88772 .50 BMG RAM PRIMING UNIT

L PRIMER CATCHER

Made to keep spent primers off the floor when ejected from fired cases. Plastic clip holds Primer Catcher snug and secure to press. Easily removed for emptying. For Rock Chucker®, JR and Reloader Special Presses only.

- 9114 PRIMER CATCHER

M PRIMER TRAY—2

The Primer Tray—2 handles today’s larger primer package quantities. The square shape makes it easier to handle. Grooved tray surface quickly positions primers anvil-side up.

- 9480 PRIMER TRAY—2

SCALES



A M500 MECHANICAL SCALE

The M500 mechanical scale provides right or left-handed operation and a wealth of big-time features at an affordable price. Featuring a proven two-poise design that lets you weigh up to 505 grains with ± 0.1 -grain accuracy, the M500 also offers RCBS' magnetic damping system for fast readings, and maintenance-free movement. The tip-proof metal pan makes loading easier, and a rugged die cast metal base even features a grain-to-gram conversion table to aid in calculations and recipe conversions. Limited lifetime warranty. Imported.

98915 M500 MECHANICAL SCALE

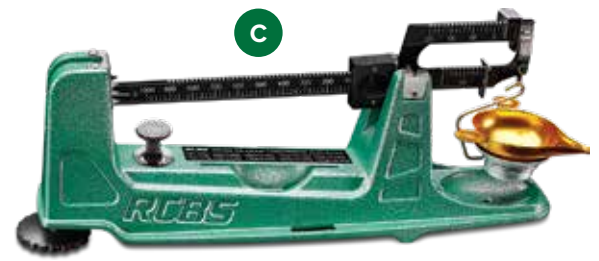

C M1000 MECHANICAL SCALE

The M1000 mechanical scale gives users 1,000-grain capacity with ± 0.1 -grain accuracy, plus right or left-handed operation. It offers magnetic damping for fast readings and maintenance-free movement. A metal tip-proof pan makes loading easy. Limited lifetime warranty. Imported. Includes storage cover.

98916 M1000 MECHANICAL SCALE



B RANGEMASTER 2000 GR 120/240 VAC/DC

The RangeMaster 2000 high-performance electronic scale handles up to 2,000 grains with ± 0.1 grain accuracy to precisely measure powder, bullets, cases or loaded cartridges. It provides right or left-handed operation and a wealth of big-time features. Compact size and the ability to operate on AC or DC power, make it perfect for use on the bench or at the range. The touchscreen LCD is easy to read and operate, and provides an auto shut off function to save the battery. The scale is fast and easy to calibrate with the two included calibration/check weights. This scale is designed for serious shooters who want the best, high-tech scale on the market, and it delivers! One year limited warranty. Imported.

98945 RANGEMASTER 2000 ELECTRONIC SCALE 120/240 VAC MULTI COUNTRY USE



D SCALE CHECK WEIGHTS

You rely on your scale for safe, accurate powder charges. Over time, accumulated grit and dust can affect accuracy. A quick test with RCBS® Scale Check Weights will tell you if your scale is reading correctly. Sets include: Standard set of 60.5 grains for powder charges (2x20, 1x10, 1x5, 2x2, 1x1, 1x.5). Deluxe set of 506.5 grains for bullets, cases and powder (1x200, 2x100, 1x50, 2x20, 1x10, 1x5, 1x1, 1x.5, 1 forceps).

*Deluxe Scale Check Weights pictured.

98991 STANDARD SCALE CHECK WEIGHTS

98993 DELUXE SCALE CHECK WEIGHTS

98917 SCALE PAN (5-0-2, 5-0-5, 5-10 & 10-10 SCALES)

98918 SCALE PAN SUPPORT (5-0-2, 5-0-5, 5-10 & 10-10 SCALES)



E SCALE PAN WITH INTEGRATED FUNNEL

Is your powder funnel always missing when you need it most? The RCBS® Scale Pan Powder Funnel eliminates that problem. The Scale Pan features an integrated powder funnel that allows you to pour the powder directly into the case. The new scale pan is designed for use with electronic scales and powder dispensers.

9090 SCALE PAN WITH INTEGRATED FUNNEL

A CHARGEMASTER™ COMBO

A



The ChargeMaster™ Combo features the ChargeMaster 1500 Scale and ChargeMaster Dispenser, preassembled to form an unmatched combination of speed and accuracy. There is no longer a need for timely calibration to the type of powder being used. Simply fill the 1 lb+ capacity powder hopper with smokeless powder, enter the desired charge and press the dispense button. Average dispensing time is under 30 seconds for a 60 grain extruded powder charge. Dispensing can be done in grains or grams mode. Accurately weighs and dispenses all extruded (stick), ball (spherical) and flake smokeless powder from 2.0 to 300 grains to ± 0.1 grain. You can store up to 30 of your favorite loads in memory for fast easy recall. The front to back layout allows easy access to the scale pan by right or left handed users. The clear cover eliminates fluctuations in weighing caused by air currents without obscuring your view of the charge being dispensed. The powder drain feature allows for convenient and easy emptying of the powder hopper. Power to the Dispenser is provided by the connection to the ChargeMaster 1500 scale so there is only one power cord to manage. One year limited warranty. Imported.

⚠ NOTE: Do NOT use with black powder!

98923 CHARGEMASTER COMBO 120 VAC US/CAN

98924 CHARGEMASTER COMBO 240 VAC INTERNATIONAL

B CHARGEMASTER™ DISPENSER

B



The ChargeMaster™ Dispenser can be added to the ChargeMaster 1500 Scale to form an unmatched combination of speed and accuracy. When the ChargeMaster Dispenser is coupled with the ChargeMaster 1500 Scale, it now has all of the same features as the ChargeMaster Combo. The individual purchasing of the units is to accommodate individual budgets. The ChargeMaster Dispenser requires the ChargeMaster 1500 Scale (sold separately) to operate. One year limited warranty. Imported.

⚠ NOTE: Do NOT use with black powder!

98922 CHARGEMASTER DISPENSER ONLY

C CHARGEMASTER™ LITE DISPENSER & SCALE

C



The RCBS® ChargeMaster™ Lite packs unparalleled powder measuring accuracy in a compact package. The one-piece unit features an LCD touchscreen display that ensures accurate data input. The hopper holds nearly a pound of smokeless powder, and can dispense anywhere between 2-300 grains with a ± 0.1 -grain accuracy. The ChargeMaster™ Lite is an effective, accurate powder-measuring tool.

⚠ NOTE: Do NOT use with black powder!

98940 CHARGEMASTER™ LITE DISPENSER & SCALE
120/240 VAC MULTI-COUNTRY USE

POWDER HANDLING



Powder Measure shown in photo not included

D ADVANCED POWDER MEASURE STAND

This stand will raise most Powder Measures 9-1/2" (with standard 7/8"-14 thread) leaving plenty of space for positioning a powder scale pan or cases in a loading block under the drop tube. Bolts easily to a reloading bench or table. Also serves as a stand for holding a Piggyback™ II, Piggyback—3 or —4 when not in use.

NOTE: Not for use with Little Dandy Powder Measure.

9092 ADVANCED POWDER MEASURE STAND

E MICROMETER ADJUSTMENT SCREW

FOR UNIFLOW™ POWDER MEASURE

The secret to faster reloading—go by the numbers. Add the UPM micrometer to your Uniflow™ Powder Measure, and you can record precise settings for your powder charges. Determine the load number and dial it in—time after time. An easy installation too; it simply replaces the Uniflow's standard metering screw.

98901 LARGE CYLINDER - .685" DIAMETER

98902 SMALL CYLINDER - .500" DIAMETER

F POWDER TRICKLER SYSTEM COMBO

The RCBS® Powder Trickler System speeds up the process of weighing your powder charges. The Powder Trickler System attaches to any Uniflow™ or standard Quick Change powder measure. Used in conjunction with the Advanced Powder Measure Stand, the Powder Trickler System allows you to dispense and trickle a powder charge directly onto a scale pan without having to remove the scale pan for the initial filling. The unit can be adjusted for right or left handed use and the dispensing chute adjusts to allow you to drop the powder charge directly onto the scale pan. With a few turns of the Trickler handle, your weighed charge is complete. The Powder Trickler System is available as a combo only.

NOTE: Not for use with Quick Change High Capacity, Little Dandy or Black Powder Measure.

9091 POWDER TRICKLER SYSTEM COMBO (PTS AND APM)



Powder Measure shown in photo not included

G CASE ACTIVATED LINKAGE KIT

Convert the Uniflow™ Powder Measure (not included) for use on most progressive presses. The Uniflow Powder Measure can have the regular Measuring Screw or the optional Micrometer Adjustment Screw installed, depending on your preference. Three powder bushings are included for most popular rifle and pistol calibers: Small Rifle for .22 through .270 calibers, Large Rifle for 7mm through .45 calibers and Pistol for .32 through .45 calibers. The powder bushings are designed to eliminate powder spillage around the case mouth. Fully adjustable for all of the different variations in case length.

98911 CASE ACTIVATED LINKAGE KIT

H COMPETITION POWDER MEASURE

The Competition Powder Measure starts with the proven Uniflow™ Powder Measure with its precision ground metering drum and honed main casting. RCBS® then adds a powder baffle and UPM Micrometer Adjustment screw. The Powder Baffle controls the powder flow and the pressure of the powder column on the metering unit. The UPM Micrometer Adjustment screw allows precise adjustments to the metered charge as well as allowing you to record the number for future reference and reuse. Handle placement can be used on the right or left side simply by changing the orientation of the metering drum. The powder measure will accurately meter, by volume, all types of smokeless powder—ball, flake or cylindrical (stick).

The Rifle unit meters volumetric powder charges from 10-110 grains. The Pistol/Small Rifle unit meters volumetric powder charges from .5 to 40 grains. The Combo unit includes both the Rifle and Pistol metering drums and complete UPM Micrometer Adjustment screw assemblies.

⚠ NOTE: Do NOT use with black powder!

NOTE: The Powder Measure should be used in conjunction with an accurate powder scale for setting the original charge and for checking charges occasionally during the run.

98908 COMPETITION POWDER MEASURE – PISTOL/SMALL RIFLE

98909 COMPETITION POWDER MEASURE – RIFLE

98910 COMPETITION POWDER MEASURE – COMBO



I UNIFLOW™ POWDER MEASURE

Throws consistently accurate charges reload after reload. Powder pours uniformly from measuring cylinder into case, thereby eliminating the hazards of “overloads” caused by clogging when charges are “dumped”. Changes easily from charge to charge without emptying powder hopper. Numbered measuring screw is used for reference to find a given charge at a later date. The measuring cylinder has precision ground surfaces and slides into the honed main casting for a precision fit. Standard 7/8”–14 thread. Includes stand plate, drilled for easy mounting on a bench or under a reloading die lock ring. Two drop tubes for .22 caliber and up are supplied. The Uniflow™ Powder Measure is fully capable of accurately measuring all three major powder types—ball, cylindrical and flake. It will even cut the cylindrical powders so that a precise charge can be obtained.

⚠ NOTE: Do NOT use with black powder!

NOTE: The Powder Measure should be used in conjunction with an accurate powder scale for setting the original charge and for checking charges occasionally during the run.

- 9010 UNIFLOW POWDER MEASURE
- 9002 UNIFLOW POWDER MEASURE SMALL
- 9004 MEASURE CYLINDER ASSEMBLY SMALL
- 86880 DUST COVER (NOT PICTURED)
- 9028 DROP TUBE .17 TO .20 CAL.

K QUICK CHANGE ACCESSORIES

The Quick Change Accessories can be used to upgrade your existing Uniflow powder measure to this system. You simply replace the metering cylinder and metering screw that came with your Uniflow with the Quick Change accessories. The QC Drop Tube Adaptor allows you to use the drop tubes from the QC High Capacity powder measure or the Drop Tube and Adaptors from the Quick Change Powder Funnel on your Uniflow or Quick Change Powder Measure.

- 98843 QC SMALL METERING SCREW ASSEMBLY
- 98844 QC LARGE METERING SCREW ASSEMBLY
- 98846 QC DRAIN ATTACHMENT
- 98845 QC METERING CYLINDER
- 98855 QC DROP TUBE ADAPTOR

L POWDER DIE

The Powder Die allows the Case Activated Powder Measure (CAPM) to be quickly moved from one Die Plate to another.

98912 POWDER DIE

J QUICK CHANGE POWDER MEASURE

The RCBS® Quick Change Powder Measure offers the ability to go from light pistol to magnum rifle charges quickly. The powder hopper has been increased in size to hold a pound of smokeless powder. The QC PM features metering assemblies that change out with the pull of a pin. Extra metering assemblies can be purchased to have them preset for your favorite smokeless powder charges. The drain attachment empties the powder hopper without the need to remove it from the stand or press. The Quick Change Powder Measure includes one each Small and Large Metering Assembly and the Drain Attachment. The Quick Change parts can be used to upgrade your existing Uniflow™ Powder Measure to this system.

⚠ NOTE: Do NOT use with black powder!

NOTE: The Powder Measure should be used in conjunction with an accurate powder scale for setting the original charge and for checking charges occasionally during the run.

- 98840 QUICK CHANGE POWDER MEASURE
- 90226 QUICK CHANGE POWDER BAFFLE



POWDER HANDLING

M



N



M QUICK CHANGE HIGH CAPACITY POWDER MEASURE

The RCBS® Quick Change High Capacity Powder Measure offers the ability to dispense large rifle charges of up to 250 grains of smokeless powder. The large hopper can accommodate two pounds of smokeless powder. The QC HC PM features metering assemblies that change out with the pull of a pin. Extra metering assemblies can be purchased to have them preset for your favorite charges. The drain attachment empties the powder hopper without the need to remove it from the stand or press. Includes one metering assembly, .22-.270 Drop tube, .30-.45 Drop Tube, .50 Drop Tube and the QC HC Drain Attachment.

⚠ NOTE: Do NOT use with black powder!

NOTE: The Powder Measure should be used in conjunction with an accurate powder scale for setting the original charge and for checking charges occasionally during the run.

98841 QC HC POWDER MEASURE
90227 QC HC POWDER BAFFLE

N QUICK CHANGE HIGH CAPACITY ACCESSORIES

The QC High Capacity Drop Tubes allow the use of these on existing Uniflow or QC powder measures.

NOTE: The Powder Measure should be used in conjunction with an accurate powder scale for setting the original charge and for checking charges occasionally during the run.

98853 QC DROP TUBE .30-.45
98852 QC DROP TUBE .22-.270

O



Powder Baffle fits inside of powder hopper and provides more even flow of powder.

P



O POWDER BAFFLE

Uniform loads require consistent powder charges, and many handloaders find a baffle helps them throw more consistent charges. The baffle is specifically designed for the RCBS® Powder Measures and provides handloaders a uniform powder flow by controlling the gravity feed pressure of the powder column on the metering unit.

90225 POWDER BAFFLE
90226 QC POWDER BAFFLE
90227 QC HC POWDER BAFFLE

P POWDER DIE FUNNEL ADAPTER

The Powder Die Funnel Adapter lets users pour weighed charges into the case at the powder drop station of their RCBS Powder Die equipped progressive press without removing it from the die plate.

98913 POWDER DIE FUNNEL ADAPTER



Q



Q

BLACK POWDER MEASURE

Answering our customers' calls for black powder products, RCBS' Black Powder Measure is sure to be a hit. The one pound capacity aluminum powder hopper and cap with a non-static powder level indicator shows you how much powder is left in the hopper. The brass non-sparking metering cylinder and adjustment screw are also features that the black powder enthusiast is looking for. The RCBS® Black Powder Measure is the perfect unit for Black Powder and Cowboy Action shooters.

98842 BLACK POWDER MEASURE

R



R

PISTOL POWDER EXPANDERS—PRO 2000 /PRO CHUCKER

Progressive pistol cartridge reloaders are starting to run out of stations on their press. If you recently added the pistol bullet feeder to your process, you either gave up your powder check or lock out station or combined bullet seating and crimping into one operation. Using the expanders in your case activated uniflow powder measure allows you to move expansion and powder drops to station two on your press.

- 88885 PISTOL POWDER EXPANDERS—PRO 2000 .38**
- 88886 PISTOL POWDER EXPANDERS—PRO 2000 9MM**
- 88887 PISTOL POWDER EXPANDERS—PRO 2000 .40**
- 88888 PISTOL POWDER EXPANDERS—PRO 2000 .44**
- 88889 PISTOL POWDER EXPANDERS—PRO 2000 .45 ACP**
- 88890 PISTOL POWDER EXPANDERS—PRO 2000 .45 COLT**
- 88892 PISTOL POWDER EXPANDERS—PRO 2000 .500**

POWDER HANDLING

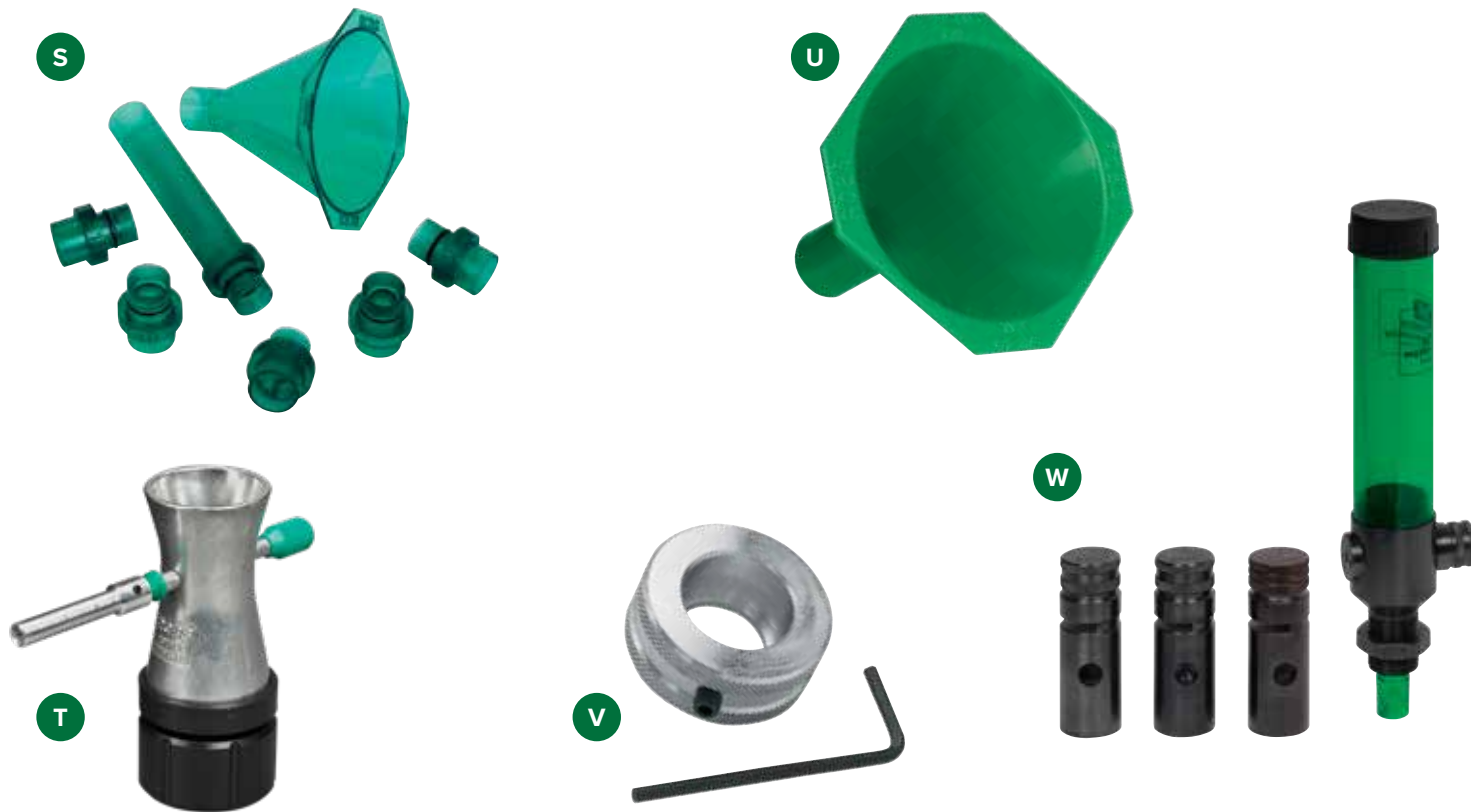

S QUICK CHANGE POWDER FUNNEL

With the current trend of large bodied rifle cases, existing powder funnels sometimes do not fit properly over the cases. The RCBS® Quick Change Powder Funnel eliminates that problem. The QC Powder Funnel features adapters that are supported by the body of the case and allow you to choose the optimum powder flow. The 4" drop tube helps to get that compressed powder charge into the case. The drop tubes are stackable so you can increase the drop length if necessary. With the adapters removed, the powder funnel allows you to return powder into the original container quickly.

9190 QUICK CHANGE POWDER FUNNEL KIT
(FUNNEL, 5 ADAPTERS AND ONE DROP TUBE)

T POWDER TRICKLER—2

Today's trend is to use electronic scales to measure powder charges. Many of these scales have scale pans that are positioned out of reach of existing powder tricklers. The Powder Trickler—2 solves this problem by adding a height adjustable, non-skid base and powder tube extension.

9089 POWDER TRICKLER—2

U POWDER FUNNEL

We've even managed to improve upon the basic plastic funnel. Ours features a specially designed drop tube to avoid any messy powder spills around case mouths, a non-stick, anti-static surface, plus a square lip to keep the funnel from rolling around. Spout will accommodate the WSM cartridges.

9087 POWDER FUNNEL .22-.50 CAL.
9086 POWDER FUNNEL .17-.20 CAL.

V LITTLE DANDY™ ROTOR KNOB

Attaches to the Little Dandy™ Rotor with a setscrew, making the rotor easier to turn. Crafted of high-strength aluminum with knurled outer surfaces for maximum finger-touch control.

86046 LITTLE DANDY ROTOR KNOB

W LITTLE DANDY™ PISTOL POWDER MEASURE

Perfect for handloading pistol shooters and select small-caliber rifle shooters. There are 28 interchangeable fixed-charge powder rotors available and you can load any popular powder with the Little Dandy™ in up to 400 different load combinations. There's no readjustment needed after changeover. Can be used hand-held or conventional bench-mounted tool with optional Powder Measure Stand.

⚠ NOTE: Do NOT use with black powder!

NOTE: The Powder Measure should be used in conjunction with an accurate powder scale for setting the original charge and for checking charges occasionally during the run.

86040 LITTLE DANDY PISTOL POWDER MEASURE

POWDER HANDLING

LITTLE DANDY™ ROTOR CHARGE TABLE

POWDER ROTOR	Part #																												
	86036	86035	86001	86002	86003	86004	86005	86006	86007	86008	86009	86010	86011	86012	86013	86014	86015	86016	86017	86018	86019	86020	86021	86022	86023	86024	86025	86026	
Rotor No.	00	0	01	02	03	04	05	06	07	08	09	10	11	12	13	14	15	16	17	18	19	20	21	22	23	24	25	26	
Bullseye	1.7	2.2	2.5	2.7	3.0	3.2	3.5	3.7	4.0	4.5	5.0	5.5	6.0	6.5	7.2	7.8	8.4	9.0	9.7	NR	NR	NR	NR	NR	NR	NR	NR	NR	
231	NR	NR	2.7	3.0	3.3	3.6	3.9	4.2	4.5	5.0	5.6	6.2	6.8	7.2	7.9	8.6	9.3	10.0	10.6	11.3	12.1	NR	NR	NR	NR	NR	NR	NR	
HP38	NR	NR	2.8	3.0	3.4	3.6	4.0	4.2	4.5	5.1	5.5	6.2	6.8	7.5	7.9	8.8	9.4	10.3	10.9	11.7	12.3	NR	NR	NR	NR	NR	NR	NR	
Red Dot	NR	NR	1.7	1.9	2.2	2.3	2.5	2.6	2.9	3.2	3.6	4.0	4.3	4.7	5.1	5.5	6.0	6.5	6.9	7.4	7.8	8.3	8.7	9.1	NR	NR	NR	NR	
700-X	NR	NR	2.0	2.2	2.4	2.6	2.8	3.0	3.2	3.6	4.0	4.4	4.8	5.1	5.7	6.2	6.8	7.3	7.7	8.2	8.7	9.2	NR	NR	NR	NR	NR	NR	
Green Dot	NR	NR	1.9	2.1	2.3	2.5	2.8	3.0	3.1	3.5	3.9	4.4	4.8	5.1	5.5	6.1	6.6	7.0	7.5	8.0	8.8	8.9	9.6	10.0	10.5	10.7	11.4	NR	
SR4756	NR	NR	NR	NR	NR	NR	NR	3.5	3.7	4.2	4.7	5.1	5.6	6.2	6.8	7.3	7.9	8.5	9.1	9.7	10.3	10.9	11.4	12.0	12.4	13.4	13.9	14.5	
HS-5	NR	NR	4.2	4.5	5.0	5.3	5.9	6.2	6.6	7.4	8.2	9.0	NR	NR	NR	NR	NR	NR	NR	NR	NR	NR	NR	NR	NR	NR	NR	NR	
Unique	NR	NR	2.3	2.5	2.8	3.0	3.3	3.5	3.7	4.2	4.7	5.2	5.7	6.0	6.6	7.2	7.8	8.4	9.0	9.5	10.1	10.7	11.3	11.8	12.4	13.1	NR	NR	
SR7625	NR	NR	2.5	2.7	3.0	3.2	3.5	3.8	4.0	4.5	5.0	5.5	6.0	6.5	7.2	7.7	8.3	9.0	9.6	NR	NR	NR	NR	NR	NR	NR	NR	NR	
HS-6	NR	NR	NR	NR	NR	NR	5.4	5.7	6.1	6.9	7.6	8.4	9.1	10.1	11.0	12.0	13.0	13.9	14.8	15.7	16.7	NR	NR	NR	NR	NR	NR	NR	
HS-7	NR	NR	NR	NR	NR	4.9	5.4	5.7	6.1	6.8	7.5	8.3	9.1	10.1	11.0	11.9	12.9	13.9	14.8	15.8	16.8	17.7	18.6	NR	NR	NR	NR	NR	
Herco	NR	NR	NR	NR	NR	NR	3.1	3.3	3.5	4.0	4.4	4.8	5.3	5.7	6.3	6.7	7.3	7.9	8.4	9.0	9.5	10.1	10.5	11.1	11.7	12.3	13.0	13.6	
Blue Dot	NR	NR	NR	NR	NR	NR	NR	NR	NR	NR	5.9	6.5	7.1	7.7	8.4	9.1	9.8	10.6	11.3	12.0	12.8	13.5	14.2	14.9	15.7	16.6	17.5	18.3	
630	NR	NR	NR	NR	5.0	5.3	5.8	6.1	6.5	7.3	8.1	8.9	9.7	10.8	11.7	12.7	13.7	14.8	15.8	16.9	17.9	18.8	19.8	20.8	NR	NR	NR	NR	
2400	NR	NR	NR	NR	NR	NR	NR	NR	NR	NR	7.0	7.7	8.4	9.3	10.2	11.0	11.9	12.8	13.6	14.6	15.4	16.2	17.0	17.9	18.9	19.8	20.8	21.8	
H110	NR	NR	NR	NR	NR	NR	NR	NR	NR	NR	NR	8.9	9.7	10.7	11.7	12.6	13.6	14.6	15.6	16.6	17.6	18.5	19.5	20.5	21.5	22.5	23.7	24.8	
296	NR	NR	NR	NR	NR	NR	NR	NR	NR	NR	NR	9.1	9.9	10.9	11.9	12.9	13.9	14.9	15.9	17.0	18.0	19.0	20.0	21.0	22.1	23.2	24.3	25.5	
SR4759	NR	NR	NR	NR	NR	NR	NR	NR	NR	NR	NR	NR	NR	NR	NR	NR	NR	NR	NR	10.1	10.7	11.5	12.2	12.8	13.5	14.2	15.0	15.8	16.5
IMR 4227	NR	NR	NR	NR	NR	NR	NR	NR	NR	NR	NR	NR	9.1	9.9	10.8	11.6	12.6	13.3	14.3	15.1	16.0	16.8	17.6	18.6	19.5	20.5	21.5	21.5	
680	NR	NR	NR	NR	NR	NR	NR	NR	NR	NR	8.2	9.1	9.9	10.9	11.9	12.9	13.9	14.9	15.9	16.9	17.9	18.9	19.9	20.9	21.9	23.1	24.2	25.3	
IMR 4198	NR	NR	NR	NR	NR	NR	NR	NR	NR	NR	6.5	7.2	7.9	8.5	9.4	10.2	11.0	12.0	12.7	13.5	14.4	15.2	16.1	16.8	17.8	18.7	19.6	20.4	
H322	NR	NR	NR	NR	NR	NR	NR	NR	NR	NR	NR	NR	NR	NR	NR	NR	NR	13.0	13.8	14.7	15.7	16.6	17.4	18.3	19.3	20.3	21.3	22.3	
Re-7	NR	NR	NR	NR	NR	NR	NR	NR	NR	NR	NR	NR	NR	NR	10.4	11.3	12.2	13.2	14.0	14.9	15.9	16.8	17.7	18.5	19.5	20.5	21.6	22.6	
Accurate Arms #2	NR	NR	3.1	3.3	3.9	4.2	4.6	4.8	5.1	5.6	6.2	6.8	7.6	8.4	9.4	10.0	10.5	11.2	12.1	12.9	13.9	15.0	16.0	16.5	16.9	18.3	19.0	19.6	
Accurate Arms #5	NR	NR	4.0	4.3	4.8	5.1	5.6	5.9	6.3	7.1	7.8	8.6	9.3	10.3	11.3	12.2	13.2	14.2	15.2	16.1	17.1	18.0	18.9	19.8	20.8	21.9	23.0	24.3	
Accurate Arms #8	NR	NR	4.2	4.6	5.1	5.4	6.0	6.3	6.6	7.5	8.3	9.1	9.9	11.0	12.0	13.0	14.4	15.0	16.0	17.0	18.0	19.0	20.0	20.9	22.0	23.1	24.3	25.7	
Accurate Arms #9	NR	NR	4.2	4.5	5.0	5.3	5.9	6.2	6.6	7.4	8.1	9.0	9.8	10.8	11.9	12.8	13.8	14.9	15.8	16.8	17.8	18.8	19.8	20.7	21.8	22.9	24.1	25.4	
Olin 473AA	NR	NR	2.8	3.1	3.4	3.7	4.0	4.2	4.5	5.0	5.5	6.1	6.6	7.4	8.1	8.7	9.3	9.9	10.9	11.4	12.1	12.8	13.3	14.1	15.0	15.5	16.4	17.0	
Olin 452AA	NR	NR	2.4	2.5	2.8	3.0	3.2	3.4	3.7	4.1	4.6	5.0	5.5	6.0	6.6	7.3	7.8	8.2	8.8	9.5	10.0	10.4	11.1	11.6	12.3	12.8	13.3	14.2	
Olin 540	NR	NR	3.9	4.3	4.7	5.0	5.6	5.9	6.2	7.0	7.7	8.5	9.2	10.2	11.1	12.1	13.0	14.0	14.9	15.9	16.8	17.8	18.9	19.6	20.7	21.7	22.7	23.9	
Olin 571	NR	NR	4.1	4.4	4.9	5.2	5.8	6.1	6.5	7.2	8.0	8.8	9.6	10.7	11.8	12.7	13.7	14.7	15.6	16.8	17.7	18.7	19.7	20.5	21.6	22.8	24.0	25.0	
Clays	NR	NR	1.8	2.0	2.2	2.3	2.6	2.7	2.9	3.3	3.6	4.0	4.4	4.8	5.3	5.7	6.1	6.6	7.0	7.5	8.0	8.4	8.9	9.2	9.8	10.3	10.8	11.4	
Universal Clays	1.7	2.2	2.5	2.8	3.0	3.1	3.3	3.8	4.0	4.5	5.0	5.5	6.0	6.6	7.3	7.9	8.5	9.1	9.8	10.5	10.9	11.7	12.2	12.7	13.4	14.2	15.0	15.7	
International Clays	1.4	1.8	2.2	2.3	2.5	2.7	3.0	3.1	3.3	3.8	4.2	4.7	5.1	5.6	6.1	6.5	7.1	7.7	8.2	8.7	9.2	9.6	10.1	10.6	11.1	11.7	12.4	12.9	
Tite Group	2.0	2.8	3.2	3.5	4.0	4.1	4.4	4.7	5.2	5.9	6.4	7.1	7.7	8.4	9.2	10.1	10.7	11.6	12.5	13.3	14.1	14.5	15.3	16.2	17.2	17.9	18.6	20.0	
Lil' Gun	NR	NR	4.1	4.6	5.3	5.4	5.7	6.1	6.6	7.4	8.2	9.2	9.9	10.8	11.8	12.9	13.8	14.9	16.0	17.1	18.0	18.7	19.8	20.8	22.1	22.9	23.6	25.7	
IMR Trail Boss	NR	NR	NR	NR	NR	1.5	1.7	1.8	1.9	2.1	2.3	2.5	2.8	3.1	3.4	3.7	4.0	4.3	4.6	4.9	5.2	5.5	5.8	6.0	6.4	6.7	7.1	7.5	
453	1.8	2.3	2.7	2.9	3.2	3.4	3.7	3.9	4.2	4.7	5.2	5.7	6.2	6.9	7.5	8.1	8.8	9.5	10.1	10.7	11.3	12.0	12.6	13.2	13.9	14.6	15.3	16.1	
Royal "D"	1.4	1.8	2.2	2.4	2.7	2.8	3.1	3.3	3.5	3.9	4.3	4.8	5.2	5.8	6.4	6.9	7.4	8.0	8.5	8.9	9.4	10.0	10.5	11.1	11.8	12.3	12.9	13.5	
Solo 1500	1.5	2.0	2.4	2.6	2.9	3.1	3.4	3.6	3.8	4.3	4.8	5.3	5.8	6.4	7.0	7.5	8.2	8.8	9.3	9.9	10.6	11.1	11.7	12.4	13.1	13.7	14.3	15.0	
N 310	1.5	1.9	2.3	2.4	2.7	2.9	3.2	3.3	3.6	4.0	4.5	4.9	5.3	5.9	6.5	7.0	7.5	8.1	8.6	9.2	9.7	10.2	10.8	11.3	11.9	12.6	13.2	13.8	
N 320	1.4	1.9	2.2	2.3	2.6	2.8	3.1	3.2	3.5	3.9	4.3	4.8	5.2	5.8	6.3	6.8	7.4	7.9	8.4	9.0	9.5	10.1	10.7	11.1	11.7	12.3	13.0	13.6	
N 330	1.6	2.1	2.5	2.7	3.0	3.2	3.5	3.7	4.0	4.5	5.0	5.5	6.0	6.6	7.2	7.8	8.4	9.0	9.8	10.3	11.0	11.6	12.2	12.8	13.5	14.1	14.8	15.6	
N 340	1.7	2.2	2.6	2.8	3.1	3.3	3.6	3.8	4.1	4.6	5.1	5.6	6.2	6.7	7.4	8.0	8.6	9.3	9.9	10.6	11.2	11.8	12.4	13.0	13.7	14.4	15.1	15.9	
N 350	1.7	2.3	2.7	2.9	3.3	3.5	3.9	4.1	4.3	4.8	5.4	6.0	6.5	7.1	7.8	8.5	9.1	9.8	10.5	11.1	11.8	12.5	13.3	13.9	14.6	15.4	16.1	16.9	
Win. Action Pistol	2.3	3.0	3.5	3.8	4.2	4.5	4.9	5.2	5.5	6.2	6.8	7.5	8.2	9.2	10.0	10.8	11.6	12.5	13.2	14.1	15.0	15.8	16.6	17.4	18.3	19.4	20.2	21.2	
IMR PB	NR	NR	2.2	2.4	2.6	2.8	3.1	3.2	3.4	3.9	4.3	4.7	5.1	5.6	6.2	6.8	7.2	7.8	8.3	8.8	9.4	10.0	10.5	10.9	11.5	12.0	12.7	13.3	
Win. Super Lite	NR	NR	3.2	3.5	3.8	4.0	4.4	4.7	4.9	5.6	6.2	6.8	7.4	8.2	9.0	9.7	10.4	11.2	12.0	12.7	13.7	14.4	15.1	15.5	16.5	17.5	18.6	19.5	
Win. Super Target	NR	NR	2.3	2.5	2.8	3.0	3.3	3.4	3.7	4.1	4.5	5.0	5.4	6.0	6.5	7.1	7.7	8.2	8.8										

SHELL HOLDERS

RCBS SHELL HOLDER CHART							
Shell Holder Number 1	9201	6.5 Remington Mag	.338-378 Weatherby Magnum	Shell Holder Number 32	9232	Shell Holder Number 48	99248
.218 Bee		.270 Weatherby Magnum	.378 Weatherby Magnum	22 PPC		.300 Norma Magnum	NEW
.25-20 Winchester		7mm Remington Magnum	.40-65 Shiloh-Sharps - .408"	6mm PPC		.338 Norma Magnum	
.32-20 Winchester		7mm Shooting Times Westerner	.45-70 U.S. Government	.264 LBC-AR		.338 Lapua Mag	
Shell Holder Number 2	9202	7mm Weatherby Magnum	.45-90-2.4" Sharps Straight	7.62mm x 39		Shell Holder Number 49	99249
.22 Savage High Power		.300 RCM	.45-100-2.6" Sharps Straight	Shell Holder Number 33	9233	.40-60 Winchester - .408"	
.25-35 Winchester		.30-338 Winchester Magnum	.45-110-2 7/8" Sharps Straight	.50 Action Express		.45-60 Winchester	
6.5mm x 55 Swedish Mauser		.300 Holland & Holland Magnum	.45-120-3 1/4" Sharps Straight	Shell Holder Number 34	9234		
7-30 Waters		.300 Weatherby Magnum	.460 Weatherby Magnum	6.5mm x 68S			
.307 Winchester		.300 Winchester Magnum	Shell Holder Number 15	8mm x 68S Magnum			
.308 Marlin Express		.308 Norma Magnum	6.5mm x 50 Japanese Arisaka	Shell Holder Number 35	99235		
.30-30 Winchester		8mm Remington Magnum	Shell Holder Number 16	.38-40 Winchester			
7.5mm x 54 French MAS		.338 RCM	.30 Luger (7.65mm Luger)	.44-40 Winchester			
7.5mm x 55 Schmidt-Rubin		.338 Winchester Magnum	.30 Mauser (7.63 Mauser)	.45 Schofield			
.32 Winchester Special		.340 Weatherby Magnum	.356 TSW	Shell Holder Number 36	99236		
.32-40 Winchester		.350 Remington Magnum	9mm FAR	.45 Winchester Magnum			
.356 Winchester		9.3mm x 74 Rimmed	9mm Luger	Shell Holder Number 37	99237		
.375 Winchester		.375 Ruger	9mm Makarov	.416 Rigby			
.38-55 Winchester & Ballard		.375 Holland & Holland Magnum	9mm x 21	.450 Rigby Rimless			
Shell Holder Number 3	9203	.416 Ruger	9mm x 23 Winchester	.500 Jeffery			
.22 Bench Rest Remington		.416 Remington Magnum	Shell Holder Number 17	Shell Holder Number 38	99238		
.22-250 Remington (.22 Varm)		.450 Marlin	.30 M1 Carbine	.26 Nosler			
.240 Weatherby Magnum		.458 Winchester Magnum	.32 Auto (7.65mm Automatic)	.27 Nosler			
.243 Winchester		.458 Lott	Shell Holder Number 18	.28 Nosler			
6mm Bench Rest Remington		.460 Smith & Wesson	.44 Magnum	.33 Nosler	NEW		
6mm Creedmoor	NEW	Shell Holder Number 5	.44 Special	6.5mm PRC	NEW		
6mm Remington (.244 Remington)		.348 Winchester	Shell Holder Number 19	6.5 RSAUM	NEW		
.25-06		Shell Holder Number 6	.30 Remington	7mm Remington Short Action Ultra Magnum			
.250 Savage (.250-3000 Savage)		.22 Remington Jet	6.8 Remington SPC	7mm Remington Ultra Magnum			
.257 Roberts		5.6mm x 50 Rimmed	Shell Holder Number 20	.30 Nosler			
.257 Roberts Improved (40") *		.357 Magnum	.45 Colt	.300 Remington Short Action Ultra Magnum			
.260 Remington		.357 Remington Maximum	.454 Casull	.300 Remington Ultra Magnum			
6.5 Creedmoor		.38 Smith & Wesson	Shell Holder Number 21	.33 Nosler			
6.5mm-06		.38 Special	.303 Savage	.338 Remington Ultra Magnum			
6.5-284 Winchester		Shell Holder Number 7	Shell Holder Number 22	.375 Remington Ultra Magnum			
6.5 x 47 Lapua		.30-40 Krag	11mm Mauser	.455 Webley			
6.5mm x 57		.303 British	43 Spanish	Shell Holder Number 39	99239		
.270 Winchester		Shell Holder Number 8	Shell Holder Number 23	.38 Super (ACP)			
.280 Ackley Imp (Nosler)		.45 Auto Rim	.32 Harrington & Richardson Mag	Shell Holder Number 40	99240		
.280 Remington (7mm Exp. Rem.)		Shell Holder Number 9	.32 Smith & Wesson Long	.475 Linebaugh			
.284 Winchester		6.5mm x 54 Mannlicher-Schoenauer	.327 Federal Mag	.480 Ruger			
7mm Bench Rest Remington		.35 Remington	Shell Holder Number 24	Shell Holder Number 41	99241		
7mm-08 Remington		Shell Holder Number 10	.405 Winchester	.404 Jeffery			
7mm x 57 Mauser (7mm Mauser)		.17 Remington	Shell Holder Number 25	Shell Holder Number 42	99242		
7mm x 64 Brenneke		.17 Remington Fireball	8mm Nambu	.376 Steyr			
.30 T/C		.204 Ruger	Shell Holder Number 26	Shell Holder Number 43	99243		
.30-06 Springfield		.221 Remington Fireball	7mm x 65 Rimmed	.223 Winchester Super Short Magnum			
.300 Savage		.222 Remington	Shell Holder Number 27	.243 Winchester Super Short Magnum			
.308 Winchester		.222 Remington Magnum	.357 Sig	.25 Winchester Super Short Magnum			
7.65mm x 53 Mauser (Belgian)		.223 Remington (5.56mm)	.40 S & W	.270 Winchester Short Magnum			
7.7mm x 58 Japanese Arisaka		.22 Nosler	10mm Auto	7mm Winchester Short Magnum			
8mm x 57 Mauser (8mm Mauser)		6mm x 45	Shell Holder Number 28	.300 Winchester Short Magnum			
8mm-06		7mm Thompson/Center Ugalde	.444 Marlin	.325 Winchester Short Magnum			
.338 Federal		.300 AAC Blackout	Shell Holder Number 29	Shell Holder Number 44	99244		
.338-06		.380 Auto Pistol	.25 Automatic (.25 ACP)	.338 Marlin Express			
.35 Whelen		9mm x 18 Ultra	Shell Holder Number 30	.500 Smith & Wesson			
.358 Winchester		Shell Holder Number 11	.30 Remington AR	Shell Holder Number 45	99245		
9.3mm x 62 Mauser		.220 Swift	.41 Magnum	5.7mm x 28 (FN)			
.370 Sako Mag/9.3x66 Sako		Shell Holder Number 12	Shell Holder Number 31	Shell Holder Number 46	99246		
.400 CorBon		.17 Hornet (Hornady)	.450x.400 Express 3" (.400 Jefry)	.470 Nitro Express 3 1/4"			
.45 Glock Action Pistol		.22 Hornet	.45-75 Winchester	.500 Nitro Express 3"			
.45 Automatic (.45 ACP)		.22 K-Hornet	.50-70 Government	Shell Holder Number 47	99247		
Shell Holder Number 4	9204	Shell Holder Number 13	.50-90-2 1/2" Sharps Straight	.408 Chey Tac			
.257 Weatherby Magnum		7.62mm x 54R Russian	.50-95 Winchester (Express)	.505 Gibbs			
.264 Winchester Magnum		Shell Holder Number 14	.56-50 Spencer				
6.5-300 Weatherby Magnum		.30-378 Weatherby Magnum					

*Shoulder angle of improved version. **If cartridge is not listed, consult the RCBS Special Order Catalog for appropriate shell holder.



A SHELL HOLDER RACK

Do you keep all of your shell holders rolling around in one box? Have you ever had trouble finding the shell holder you need? With RCBS's Shell Holder Rack, you can keep your shell holders organized and protected. The Shell Holder Rack has 12 positions that hold two shell holders on each post. There is also room to store six Trim Pro® Shell Holders as well. The clear cover keeps out the dust and dirt while allowing you to see what is stored in the rack.

The Shell Holder Rack can be mounted on the wall or used on the bench. The wall mount spacing allows it to be hung off of standard 1" pegboard hooks as well. The support legs angle the bottom out for wall mounting or the top up for bench use. Additional Shell Holder Racks can be snapped together if more shell holder storage is needed.

9461 SHELL HOLDER RACK

B STUCK CASE REMOVER

Our Stuck Case Remover extracts stuck cases from standard sized dies without damaging the die, using a very simple two-step removal process.

9340 STUCK CASE REMOVER

C STUCK CASE REMOVER—2 KIT

The Stuck Case Remover—2 Kit lets you extract cases from dies with removable guide bushings. It's also useful for our Competition Dies or other sized dies with a raised expander ball. Kit contains two extractor nuts and two punch rods.

9355 STUCK CASE REMOVER—2 KIT

5-STATION SHELL PLATES

Plate Size	Part Number	Plate Size	Part Number
Number 1	88801	Number 18	88818
Number 2	88802	Number 19	88819
Number 3	88803	Number 20	88820
Number 4	88804	Number 23	88823
Number 5	88805	Number 27	88827
Number 6	88806	Number 30	88830
Number 7	88807	Number 31	88831
Number 8	88808	Number 32	88832
Number 9	88809	Number 33	88833
Number 10	88810	Number 35	88835
Number 11	88811	Number 38	88838
Number 12	88812	Number 39	88839
Number 13	88813	Number 40	88840
Number 14	88814	Number 43	88843
Number 16	88816	Number 44	88844
Number 17	88817	Number 45	88845

For Pro 2000, AmmoMaster Auto, Piggyback and Piggyback II Progressive Presses

Note: The Piggyback and Piggyback II Progressive Presses are restricted to an overall cartridge length of 2.260". Check cartridge length before ordering Shell Plates.

See Reference Chart on pages 40-41

EXTENDED SHELL HOLDERS

Part Number	#	Part Number	#
8952	2	8960	10
8953	3	8968	18
8956	6	8995	45

REFERENCE CHARTS

Caliber	Die Group	Shell Holder & Shell Plate Number	Primer Plug & Sleeve Size	Case Trimmer Collet Number*	Case Trimmer Pilot Caliber	Ammo Box Size	Lube Die
.17 Hornet (Hornady)	D	12	Small	2	17	MP	-
.17 Remington	A & GM	10	Small	1	17	SR	-
.17 Remington Fireball	A & GM	10	Small	1	17	SR	-
.204 Ruger	A, GM & AR	10	Small	1	20	SR	-
.218 Bee	A	1	Small	2	22	MP	-
.22 Bench Rest	GM	3	Small	3	22	MR	1
.22 PPC	GM	32	Small	3	22	MR	1
.22 Hornet	A & GM	12	Small	2	22	MP	-
.22 K-Hornet	D	12	Small	2	22	MP	-
.22 Remington Jet	D	6	Small	3	22	MP	-
.22 Savage High-Power	D	2	Large	2	22	MR	3
.22-250 Remington (22 Varminter)	A & GM	3	Large	1	22	MR	2
.220 Swift	A & GM	11	Large	1	22	MR	3
.221 Remington Fireball	A & GM	10	Small	1	22	SR	1
.222 Remington	A & GM	10	Small	1	22	SR	1
.222 Remington Magnum	A	10	Small	1	22	SR	1
.223 Remington (5.56mm)	A, GM & AR	10	Small	1	22	SR	1
.22 Nosler	D & AR	10	Small	1	22	SR	1
.223 Winchester Super Short Mag	A & GM	43 (5)	Large	1	22	(4)	-
.224 Valkrie NEW	D, GM & AR	19	Small	2	22	MR	3
5.6mm x 50 Rimmed	D	6	Small	2	22	SR	-
5.7mm x 28 (FN)	D	45	Small	(4)	22	SR/MP	-
.240 Weatherby Magnum	A	3	Large	1	24	LR	2
.243 Winchester Super Short Mag	A & GM	43 (5)	Large	1	24	(4)	2
.243 Winchester	A & GM	3	Large	1	24	MR	2
6mm Bench Rest	GM	3	Small	3	24	MR	1
6mm Creedmoor NEW	D & GM	3	Lg/Sm	1	24	LR	2
6mm PPC	A & GM	32	Small	3	24	MR	1
6mm x 45	D & AR	10	Small	1	24	SR	1
6mm Remington (244 Remington)	A & GM	3	Large	1	24	MR	2
.25 Auto (25 ACP)	E	29 (6)	Small	(4)	(4)	(4)	-
.25 Winchester Super Short Mag	A & GM	43 (5)	Large	1	25	(4)	-
.25-06	A & GM	3	Large	1	25	LR	2
.25-20 Winchester	A	1	Small	2	25	MP	-
.25-35 Winchester	A	2	Large	2	25	MR	3
.250 Savage (250-3000 Savage)	A	3	Large	1	25	MR	2
.257 Roberts	A	3/11	Large	1	25	MR	2
.257 Roberts Improved 40°	D	3/11	Large	1	25	MR	2
.257 Weatherby Magnum	A	4	Large	1	25	LR	4
.260 Remington	A, GM & AR	3	Large	1	26	MR	2
.26 Nosler	D	38 (5)	Large	1	26	LR	-
.264 LBC-AR	D & AR	32	Large	1	26	MR	3
.264 Winchester Magnum	A	4/26	Large	1	26	LR	4
6.5-300 Weatherby Magnum	D	4/26	Large	1	26	LR	4
6.5 Remington Magnum	D	4/26	Large	1	26	LR	4
6.5mm-06	D	3	Large	1	26	LR	2
6.5-284 Winchester	D & GM	3	Large	1	26	LR	4
6.5 Creedmoor	A, GM & AR	3	Large	1	26	LR	2
6.5mm x 47 Lapua	D & GM	3	Large	1	26	MR	3
6.5 x 54 Mannlicher-Schoenauer	D	9	Large	1	26	LR	-
6.5mm PRC NEW	D & GM	38	Large	1	26	LR	-
6.5mm x 55 Swedish Mauser	A & GM	2	Large	1	26	LR	2
6.5 RSAUM NEW	D & GM	38	Large	1	26	(4)	-
6.5mm x 57 Mauser	D	3	Large	1	26	LR	2
6.5mm x 68S	D	34 (5)	Large (2)	2	26	LR	4
6.8 Remington SPC	A & AR	19	Large	2	27	MR	3
.270 Weatherby Magnum	A	4	Large	1	27	LR	4
.270 Winchester	A & GM	3	Large	1	27	LR	2
.270 Winchester Short Magnum	A & GM	43 (5)	Large	1	27	(4)	-
.27 Nosler	D	38 (5)	Large	1	27	LR	-
.280 Ackley Improved (Nosler)	D	3	Large	1	28	LR	2
.280 Remington (7mm Exp. Rem.)	A & GM	3	Large	1	28	LR	2

Caliber	Die Group	Shell Holder & Shell Plate Number	Primer Plug & Sleeve Size	Case Trimmer Collet Number*	Case Trimmer Pilot Caliber	Ammo Box Size	Lube Die
.28 Nosler	D	38 (5)	Large	1	28	LR	-
.284 Winchester	A	3	Large	1	28	MR	4
7mm Bench Rest Remington	D & GM	3	Small	1	28	MR	2
7mm Remington Magnum	A & GM	4/26	Large	1	28	LR	4
7mm Remington SA Ultra Magnum	A & GM	38/4 (5)	Large	1	28	(4)	-
7mm Remington Ultra Magnum	A & GM	38/4 (5)	Large	1	28	(4)	-
7mm Shooting Times Westerner	A & GM	4	Large	1	28	LR	4
7mm Thompson/Center Ugalde	A & GM	10	Small	1	28	SR	1
7mm Weatherby Magnum	A	4	Large	1	28	LR	4
7mm Winchester Short Magnum	A & GM	43 (5)	Large	1	28	(4)	-
7mm-08 Remington	A & GM	3	Large	1	28	MR	2
7mm x 57 Mauser (7mm Mauser)	A & GM	3/11	Large	1	28	LR	2
7mm x 64 Brenneke	A	3	Large	1	28	LR	2
7mm x 65 Rimmed	D	26	Large	1	28	LR	2
7-30 Waters	A & GM	2	Large	2	28	MR	3
.30 M-1 Carbine	C	17	Small	3	30	MP	-
.30 Luger (7.65mm Luger)	A	16	Small	2	30	(4)	-
.30 Mauser (7.63mm Mauser)	D	16	Small	2	30	(4)	-
.30 Nosler	D	38 (5)	Large	1	30	LR	-
.30 Remington	D	19	Large	2	30	MR	3
.30 Remington AR	D & AR	30	Large	2	30	MR	3
.30 T/C	A	3	Large	1	30	MR	2
.30-06 Springfield	A, GM & AR	3	Large	1	30	LR	2
.30-30 Winchester	A	2	Large	2	30	MR	3
.30-338 Winchester Magnum	D	4	Large	1	30	LR	4
.30-378 Weatherby Magnum	A & GM	14 (5)	Large	4	30	(4)	-
.30-40 Krag	A	7	Large	3	30	LR	-
.300 AAC Blackout	D & AR	10	Small	1	30	SR	1
.300 H&H Magnum	D	4	Large	1	30	LR	4
.300 Norma Magnum NEW	D & GM	48	Large	4	30	(4)	-
.300 Remington SA Ultra Magnum	A & GM	38/4 (5)	Large	1	30	(4)	-
.300 Remington Ultra Magnum	A & GM	38/4 (5)	Large	1	30	(4)	-
.300 RCM	A	4	Large	1	30	MR	2
.300 Savage	A	3	Large	1	30	MR	2
.300 Weatherby Magnum	A & GM	4	Large	1	30	LR	4
.300 Winchester Magnum	A & GM	4/26	Large	1	30	LR	4
.300 Winchester Short Magnum	A & GM	43 (5)	Large	1	30	(4)	-
.303 British	A	7	Large	1	31	LR	-
.307 Winchester	A	2	Large	2	30	MR	2
.308 Norma Magnum	D	4	Large	1	30	LR	4
.308 Winchester	A, GM & AR	3	Large	1	30	MR	2
.308 Marlin Express	A	2	Large	1	30	MR	2
7.5mm x 54 French MAS	D	2	Large	1	30	LR	2
7.5mm x 55 Schmidt-Rubin	A	2	Large	2	30	LR	-
7.62mm x 39-.308/.311	A & AR	32	Large	3	30/31	MR	3
7.62mm x 54R Russian	A	13 (5)	Large	4	30	LR	-
7.65mm x 53 Belgian Mauser	A	3	Large	1	31	LR	2
7.7mm x 58 Japanese Arisaka	A	3/2	Large	1	31	LR	2
.32 Automatic (7.65mm Auto)	B	17	Small	1	31	(4)	-
.32 H&R Magnum	E	23	Small	1	31	(4)	-
.32 Smith & Wesson Long	E	23	Small	1	31	(4)	-
.327 Federal Magnum	E	23	Small	1	31	(4)	-
.32 Winchester Special	A	2	Large	2	32	MR	3
.32-20 Winchester	E	1	Small	2	31	MP	-
.32-40 Winchester	D	2	Large	2	32	MR	3
8mm Remington Magnum	A	4	Large	1	32	LR	4
8mm-06	D	3	Large	1	32	LR	2
8mm x 57 Mauser (8mm Mauser)	A	3	Large	1	32	LR	2
8mm x 68S Magnum	D	34 (5)	Large	2	32	LR	-
.325 Winchester Short Magnum	A	43 (5)	Large	1	32	LR	-
.338 Federal	A & AR	3	Large	1	33	MR	2
.338 Lapua	A & GM	48 (6)	Large	4	33	(4)	-

REFERENCE CHARTS

Caliber	Die Group	Shell Holder & Shell Plate Number	Primer Plug & Sleeve Size	Case Trimmer Collet Number*	Case Trimmer Pilot Caliber	Ammo Box Size	Lube Die
.338 RCM	A	4	Large	1	33	MR	2
.338 Marlin Express	D	44	Large	-	33	LR	-
.338 Winchester Magnum	A	4	Large	1	33	LR	-
.338-06/.338-06 A-Square	D	3	Large	1	33	LR	2
.338 Norma Mag	D	48	Large	-	33	LR	2
.33 Nosler NEW	D	38/4 (5)	Large	1	33	(4)	-
.338 Remington Ultra Magnum	A	38/4 (5)	Large	1	33	(4)	-
.338-378 Weatherby Magnum	A	14	Large	4	33	(4)	-
.340 Weatherby Magnum	A	4	Large	1	33	LR	4
.348 Winchester	D	5 (5)	Large	4	34	MR	-
.35 Remington	A	9	Large	1	35	MR	3
.35 Whelen	A	3	Large	1	35	LR	2
.350 Remington Magnum	D	4	Large	1	35	MR	4
.356 TSW	B	16	Small	2	35	(4)	-
.356 Winchester	A	2	Large	2	35	MR	2
.357 Magnum	B	6	Small	3	35	MP	-
.357 Remington Maximum	B	6	Small	3	35	SR	-
.357 Sig	A	27	Small	3	35	LP	-
.358 Winchester	A	3	Large	1	35	MR	2
9mm FAR	E	16	Small	2	35	MP	-
9mm x 18 Ultra	B	10	Small	2	35	(4)	-
9mm Luger	B	16	Small	2	35	(4)	-
9mm Makarov	E	16	Small	2	35	(4)	-
9mm x 21	B	16	Small	2	35	(4)	-
9mm x 23 Winchester	B	16	Small	2	35	(4)	-
.370 Sako Magnum/9.3x66 Sako	D	3	Large	1	36	LR	-
9.3mm x 62 Mauser	A	3	Large (2)	1	36	LR	2
9.3mm x 74R	D	4	Large	1	36	LR	-
.375 H&H Magnum	A	4	Large	1	37	LR	4
.375 Remington Ultra Mag	A	38/4 (5)	Large	1	37	(4)	-
.375 Ruger	A	4	Large	2	37	MR	3
.375 Winchester	C	2	Large	2	37	MR	3
.376 Steyr	D	42	Large	2	37	LR	4
.378 Weatherby Magnum	D	14 (5)	Large	4	37	(4)	-
.38 Colt Super Auto (.38 ACP)	E	39	Small	2	35	MP	-
.38 Smith & Wesson	COWBOY	6	Small	3	35	MP	-
.38 Special	B	6	Small	3	35	MP	-
.380 Automatic Pistol	B	10	Small	1	35	(4)	-
.38-40 Winchester	E	35 (5)	Large	1	40	LP	-
.38-55 Winchester & Ballard	LEGACY & COWBOY	2	Large	2	37	MR	3
.40 S&W	B	27	Small	3	40	LP	-
.400 CorBon	D	3	Large	1	40	LP	2
.40-60 Winchester - .408"	LEGACY	49 (6)	Large	4	41	(4)	4
.40-65 Shiloh Sharps - .408"	LEGACY	14 (5)	Large	4	41	(4)	4
.40-70-2 1/2" Sharps Straight	LEGACY	14 (5)	Large	4	41	(4)	4
.404 Jeffery	SAFARI	41 (5)	Large	HC#2	n/a	(4)	-

Caliber	Die Group	Shell Holder & Shell Plate Number	Primer Plug & Sleeve Size	Case Trimmer Collet Number*	Case Trimmer Pilot Caliber	Ammo Box Size	Lube Die
.405 Winchester	LEGACY	24	Large	3	40	(4)	3
10mm Auto	B	27	Large	3	40	LP	-
.41 Magnum	B	30	Large	2	41	LP	4
.416 Ruger	D	4	Large	1	416	LR	-
.416 Remington Magnum	D	4	Large	1	416	LR	-
.416 Rigby	D	37 (5)	Large	4	416	(4)	-
.416 Barrett	1 1/2"-12	.50 BMG	.50 BMG	.50 BMG	416	(4)	-
.44 Magnum	B	18	Large	2	44	LP	-
.44 S&W Russian	COWBOY	18	Large	2	44	LP	-
.44 Special	B	18	Large	2	44	LP	-
.444 Marlin	C	28	Large	1	44	LR	-
.44-40 Winchester	B	35 (5)	Large	1	44	LP	-
.45 Automatic (45 ACP)	B	3	Large	1	45	LP	2
.45 Auto Rim	B	8	Large	1	45	LP	2
.45 Glock Action Pistol	B	3	Large	1	45	LP	2
.45 Colt	B	20	Large	1	45	LP	-
.45 S&W Schofield	COWBOY	35	Large	1	45	LP	-
.45-60 Winchester	LEGACY	49 (6)	Large	4	45-R	(4)	4
.45-70 U.S. Government	C & COWBOY	14 (6)	Large	4	45-R	(4)	4
.45-75 Winchester	LEGACY	31 (5)	Large	4	45-R	(4)	4
.45-90-2.4" Sharps Straight	LEGACY	14 (5)	Large	4	45-R	(4)	4
.45-100-2.6" Sharps Straight	LEGACY	14 (5)	Large	4	45-R	(4)	4
.45-110-2 7/8" Sharps Straight	LEGACY	14 (5)	Large	4	45-R	(4)	4
.45-120-3 1/4" Sharps Straight	LEGACY	14 (5)	Large	4	45-R	(4)	4
.450 Marlin	C	4	Large	1	45-R	LR	4
.450x.400 Express 3"(.400 Jeffery)	SAFARI	31 (5)	Large	.50 BMG	41	(4)	-
.450 Rigby Rimless	SAFARI	37 (5)	Large	HC#2	45-R	(4)	-
.454 Casull	B	20	Large	1	45	(4)	-
.458 Winchester Magnum	C	4	Large	1	45-R	LR	4
.458 Lott	C	4	Large	1	45-R	LR	4
.460 Weatherby Magnum	D	14 (5)	Large	4	45-R	(4)	-
.460 Smith & Wesson	B	4	Large	-	45	(4)	-
.460 Steyr	1 1/2"-12	.50 BMG	.50 BMG	.50 BMG	45-R	(4)	-
.470 Nitro Express 3 1/4"	SAFARI	46 (6)	Large	HC#1	475	(4)	-
.475 Linebaugh 1.400"	B	40 (5)	Large	1	475	(4)	-
.480 Ruger	B	40 (5)	Large	1	475	(4)	-
.50 Action Express	B	33 (5)	Large	1	50	(4)	-
.50-70 Gov't	LEGACY	31 (5)	Large	4	50	(4)	4
.50-90-2 1/2" Sharps Straight	LEGACY	31 (5)	Large	4	50	(4)	4
.50-95 Winchester (Express)	LEGACY	31 (5)	Large	4	50	(4)	4
.500 Smith & Wesson	B	44 (5)	Large	-	50	(4)	-
.500 Jeffery	SAFARI	37 (5)	Large	HC#1	50-R	(4)	-
.500 Nitro Express	SAFARI	46 (6)	Large	HC#1	50-R	(4)	-
.56-50 Spencer	LEGACY	31 (5)	Large	-	50	(4)	-
.50 BMG	1 1/2"-12	.50 BMG	.50 BMG	.50 BMG	50-R	(4)	-
.505 Gibbs	SAFARI	47 (6)	Large	.50 BMG	50-R	(4)	-

IMPORTANT: RCBS Shell Holder numbers do not correspond to those of other manufacturers. When two Shell Holders are listed, the most popular is shown first. It may be necessary to use the alternate, depending on the manufacturer and/or lot of cases being used.

THE NUMERALS IN () IN THE TABLE INDICATE THE FOLLOWING:

(2) cases are usually Berdan primed. Depriming and priming must be done by hand. If cases were formed from cases having boxer-type primers, use the appropriate Shell Holder for that caliber.

(4) not available.

(5) Auto 4X4 Shell Plate not available.

(6) Auto 4X4 and Five-Station Shell Plates not available.

AMMO BOX SIZE CODE:

SR=Small Rifle, MR=Medium Rifle, LR=Large Rifle, MP=Medium Pistol, LP=Large Pistol.

* Rotary Case Trimmer—2 only. ** For Ten-X

RELOADING DIES

A



B



A PRECISIONEERED® DIES

For shooters who demand reloads equal to the quality of their guns. Each RCBS Die is made from case hardened steel. The inside surfaces of all dies are precision-drilled and reamed to the same exacting standards as the finest gun mechanisms.

Full-Length Sizer Dies for bottleneck cases have vents to prevent case damage caused by trapped air and for excessive lubricant. Headspace is held to minimum tolerances to avoid changing the case body length during full length sizing.

Dies are properly hardened and hand polished. This special RCBS finishing produces a die that will withstand years and years of the abrasive type of wear caused by case sizing.

All RCBS Seater Dies have a built-in roll or taper crimp as appropriate for the particular caliber. To seat bullets without crimping, simply unscrew the die until the crimp ring no longer engages the case mouth.

Large, easy-to-adjust hex lock rings utilize hex head set screws. Unless otherwise noted, all RCBS Precisioneered Dies have the standard 7/8"-14 thread. Dies are packaged in stackable, plastic storage boxes specially designed to protect the dies in shipping. Includes loading data label.

B TUNGSTEN CARBIDE DIE SETS (GROUPS B, C, & E)

The Carbide Sizer Die eliminates the need for case lubrication and cases do not need to be cleaned before sizing. Carbide Die Sets consist of a Carbide Sizer Die with Decapping Unit, Expander Die for expanding and belling the case mouth, plus a Seater Die with Roll or Taper Crimp and Bullet Seater Plug. Carbide Sizer Dies are also available separately. Available in most popular handgun calibers and .30 M-1 Carbine. See die listings for caliber availability.

Note: Due to the length of the .30 M-1 Carbine Carbide insert, every fourth or fifth case should be lightly lubricated to eliminate sticking cases.

2-DIE SETS (GROUPS A, D & SAFARI)

2-Die Sets are for bottleneck type rifle and pistol cases, and consist of a Full-Length Sizer Die with Expander-Decapping Unit, and a Seater Die with Bullet Seater Plug.

NECK DIE SETS (GROUPS A & D)

Neck Sizer Dies size only the neck of case (not the shoulder or body) just enough to snugly hold the bullet. Neck Die Sets consist of a Neck Sizer Die with Expander-Decapping Unit and a regular Seater Die with Seater Plug. Neck Sizer Dies are also available individually. Available in most calibers.

See listings on the following pages.

3-DIE SETS (GROUPS B, C, E, LEGACY & SAFARI)

RCBS pioneered and developed the 3-Die Sets for straight-wall rifle and pistol cases. In the 3-Die Set, sizing and expanding (belling) are done in separate dies. The 3-Die Set has a Sizer Die with Decapping Unit, Expander Die for expanding and belling the case mouth and a Seater Die with Roll or Taper Crimp and Bullet Seater Plug(s) for seating and crimping the bullet.





STEEL NECK BUSHINGS

Neck Bushing Diameter	Part Number	Neck Bushing Diameter	Part Number	Neck Bushing Diameter	Part Number	Neck Bushing Diameter	Part Number
0.185	81500	0.231	81546	0.277	81592	0.323	81638
0.186	81501	0.232	—	0.278	81593	0.324	81639
0.187	81502	0.233	81548	0.279	—	0.325	81640
0.188	81503	0.234	81549	0.280	81595	0.326	81641
0.189	—	0.235	81550	0.281	81596	0.327	81642
0.190	—	0.236	81551	0.282	81597	0.328	81643
0.191	81506	0.237	81552	0.283	81598	0.329	81644
0.192	81507	0.238	81553	0.284	81599	0.330	81645
0.193	81508	0.239	81554	0.285	81600	0.331	81646
0.194	81509	0.240	81555	0.286	81601	0.332	81647
0.195	81510	0.241	81556	0.287	81602	0.333	81648
0.196	81511	0.242	81557	0.288	81603	0.334	81649
0.197	81512	0.243	81558	0.289	81604	0.335	81650
0.198	81513	0.244	81559	0.290	81605	0.336	81651
0.199	81514	0.245	81560	0.291	81606	0.337	81652
0.200	81515	0.246	81561	0.292	81607	0.338	81653
0.201	—	0.247	81562	0.293	81608	0.339	81654
0.202	81517	0.248	81563	0.294	81609	0.340	81655
0.203	81518	0.249	81564	0.295	81610	0.341	81656
0.204	81519	0.250	81565	0.296	81611	0.342	81657
0.205	81520	0.251	81566	0.297	81612	0.343	81658
0.206	81521	0.252	81567	0.298	81613	0.344	81659
0.207	81522	0.253	81568	0.299	81614	0.345	81660
0.208	—	0.254	81569	0.300	81615	0.346	81661
0.209	—	0.255	81570	0.301	81616	0.347	81662
0.210	81525	0.256	81571	0.302	81617	0.348	81663
0.211	81526	0.257	81572	0.303	81618	0.349	81664
0.212	81527	0.258	81573	0.304	81619	0.350	81665
0.213	81528	0.259	81574	0.305	81620	0.351	81666
0.214	81529	0.260	81575	0.306	81621	0.352	81667
0.215	81530	0.261	81576	0.307	81622	0.353	81668
0.216	81531	0.262	81577	0.308	81623	0.354	81669
0.217	81532	0.263	81578	0.309	81624	0.355	81670
0.218	81533	0.264	81579	0.310	81625	0.356	81671
0.219	81534	0.265	81580	0.311	81626	0.357	81672
0.220	81535	0.266	81581	0.312	81627	0.358	81673
0.221	81536	0.267	81582	0.313	81628	0.359	81674
0.222	81537	0.268	81583	0.314	81629	0.360	81675
0.223	81538	0.269	81584	0.315	81630	0.361	81676
0.224	81539	0.270	81585	0.316	81631	0.362	81677
0.225	81540	0.271	81586	0.317	81632	0.363	81678
0.226	81541	0.272	81587	0.318	81633	0.364	81679
0.227	81542	0.273	81588	0.319	81634	0.365	81680
0.228	81543	0.274	81589	0.320	81635		
0.229	81544	0.275	81590	0.321	81636		
0.230	81545	0.276	81591	0.322	81637		

COATED NECK BUSHINGS

Neck Bushing Diameter	Part Number	Neck Bushing Diameter	Part Number	Neck Bushing Diameter	Part Number	Neck Bushing Diameter	Part Number
0.185	81700	0.231	—	0.277	81792	0.323	81838
0.186	81701	0.232	81747	0.278	81793	0.324	81839
0.187	81702	0.233	81748	0.279	81794	0.325	81840
0.188	81703	0.234	81749	0.280	81795	0.326	—
0.189	81704	0.235	81750	0.281	81796	0.327	81842
0.190	81705	0.236	81751	0.282	81797	0.328	81843
0.191	81706	0.237	81752	0.283	81798	0.329	81844
0.192	81707	0.238	81753	0.284	81799	0.330	81845
0.193	81708	0.239	81754	0.285	81800	0.331	81846
0.194	81709	0.240	81755	0.286	81801	0.332	81847
0.195	81710	0.241	81756	0.287	81802	0.333	81848
0.196	81711	0.242	81757	0.288	81803	0.334	81849
0.197	81712	0.243	81758	0.289	81804	0.335	81850
0.198	81713	0.244	81759	0.290	81805	0.336	81851
0.199	81714	0.245	81760	0.291	81806	0.337	81852
0.200	81715	0.246	81761	0.292	81807	0.338	81853
0.201	81716	0.247	81762	0.293	81808	0.339	81854
0.202	81717	0.248	81763	0.294	81809	0.340	81855
0.203	81718	0.249	81764	0.295	81810	0.341	81856
0.204	81719	0.250	81765	0.296	81811	0.342	81857
0.205	81720	0.251	81766	0.297	81812	0.343	81858
0.206	81721	0.252	81767	0.298	81813	0.344	81859
0.207	81722	0.253	81768	0.299	81814	0.345	—
0.208	81723	0.254	81769	0.300	81815	0.346	—
0.209	81724	0.255	81770	0.301	81816	0.347	81862
0.210	81725	0.256	81771	0.302	81817	0.348	81863
0.211	81726	0.257	81772	0.303	81818	0.349	81864
0.212	81727	0.258	81773	0.304	81819	0.350	81865
0.213	—	0.259	81774	0.305	81820	0.351	81866
0.214	81729	0.260	81775	0.306	81821	0.352	81867
0.215	81730	0.261	81776	0.307	81822	0.353	81868
0.216	81731	0.262	81777	0.308	81823	0.354	81869
0.217	81732	0.263	81778	0.309	81824	0.355	81870
0.218	81733	0.264	81779	0.310	81825	0.356	81871
0.219	81734	0.265	81780	0.311	81826	0.357	81872
0.220	81735	0.266	81781	0.312	81827	0.358	81873
0.221	81736	0.267	81782	0.313	81828	0.359	81874
0.222	81737	0.268	81783	0.314	81829	0.360	81875
0.223	81738	0.269	81784	0.315	81830	0.361	81876
0.224	81739	0.270	81785	0.316	81831	0.362	81877
0.225	81740	0.271	81786	0.317	81832	0.363	81878
0.226	81741	0.272	81787	0.318	81833	0.364	81879
0.227	81742	0.273	81788	0.319	—	0.365	81880
0.228	81743	0.274	81789	0.320	—		
0.229	81744	0.275	81790	0.321	—		
0.230	81745	0.276	81791	0.322	—		

RELOADING DIES

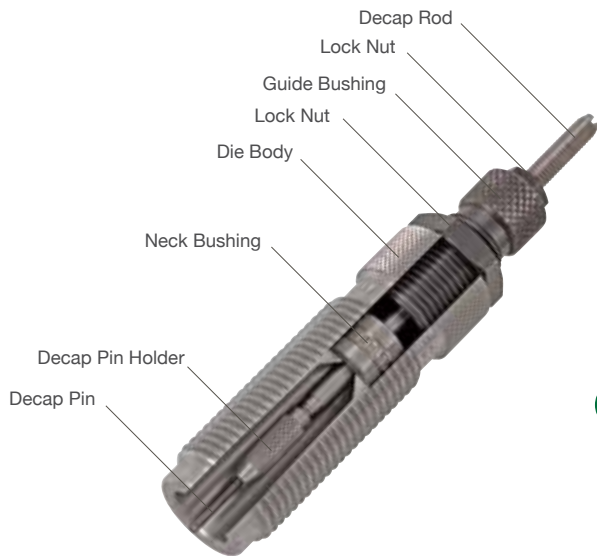

C GOLD MEDAL MATCH SERIES DIES

RCBS® is proud of our Gold Medal series of neck bushing rifle dies. This changeable diameter neck bushing type of die has been used by Bench Rest and Long Range Precision shooters for years.

Due to variability in neck brass thickness, RCBS standard dies size the neck below your desired diameter and then pull an expander ball through to get the proper bullet tension. The Gold Medal sizing die features a self-centering, changeable neck bushing that allows you to precisely set the amount of tension on the bullet. This reduces work hardening of the case neck brass, prolonging case life and increasing accuracy. Neck bushings are available in .001" increments from .189" to .365".

The Gold Medal rifle dies are available in Full-Length and Neck sizing styles. By removing the neck bushing, the Full-Length sizing die can be used as a "bump" die to set headspace back the desired amount.

Neck bushings are not included. Proper neck bushing size can be determined two ways. Measure the outside neck diameter of your loaded cartridge, subtract .002" to .003". This allows approximately .001" of brass to spring back for correct neck tension. The other is to measure the neck wall thickness of your case, multiply by two, add the diameter of your bullet and subtract .001". RCBS suggests that you have neck bushings one to two sizes above and below your target diameter.

The Gold Medal seat dies feature a micrometer adjustable, free floating and self centering bullet seating system with a convenient bullet loading window. The Gold Medal seat die can also be used on progressive presses with the exception of the .221 Rem Fireball, .17 Rem Fireball and .22 Hornet cartridges.

SPECIAL ORDER SETS

If you cannot find your dies listed on the reference chart on pages 40-41 of this catalog, please consult the RCBS Special Order catalog.

See charts on following pages for part numbers.

*Competition extended shell holder required for bullet seating is included.

NOTE: If not in stock, allow 4-6 weeks for delivery.

GOLD MEDAL MATCH							
Caliber	Full Length Neck Bushing Die Set	Full Length Neck Bushing Sizer Die	Neck Bushing Die Set	Neck Bushing Sizer Die	Gold Medal Seater Die	Decap Unit	Decap Assy
.17 REM FIREBALL*	16205	16234	16206	16235	16249	9882	—
.17 REM	17205	17234	17206	17235	17249	9882	—
.204 RUGER	10305	10334	10306	10335	10349	9801	—
.22 HORNET*	10205	10234	10206	10235	10249	9802	—
.22 BENCH REST	29905	29934	29906	29935	29949	—	—
.22-250 REM (.22 VAR.)	10605	10634	10606	10635	10649	9802	—
.220 SWIFT	10705	10734	10706	—	10749	9802	—
.221 REM FIREBALL*	10805	10834	—	10835	10849	9802	—
.222 REM	10905	10934	10906	10935	10949	9802	—
.223 REM (5.56MM)	11105	11134	11106	11135	11149	9802	—
.223 WSSM	10505	10534	10506	10535	10549	9802	—
.224 VALKYRIE	11205	—	—	11235	11249	—	9802
.243 WIN	11405	11434	11406	11435	11449	9805	—
6MM BENCH REST	16105	16134	16106	16135	16149	—	—
6MM PPC	22605	22634	22606	22635	22649	—	—
6MM REM (.244 REM)	11505	11534	11506	11535	11549	9805	—
6MM CREEDMOOR	31805	—	—	31835	31849	—	9805
.25-06	12005	12034	12006	12035	12049	9806	—
6.5MM CREEDMOOR	32905	32934	32906	32935	32949	—	9806
6.5 RSAUM	31905	—	—	31935	31949	—	9806
6.5MM PRC	32105	—	—	32135	32149	—	9806
6.5MM-.284 WINCHESTER	28705	28734	28706	28735	28749	9807	—
6.5X55 SWEDISH MAUSER	13205	13234	13206	13235	13249	9808	—
6.5X47 LAPUA	12905	12934	12906	12935	12949	—	—
.260 REM	12805	12834	12806	12835	12849	—	—
.270 WIN	13505	13534	13506	13535	13549	9808	—
.270 WIN SHORT MAG	31305	—	31306	31335	31349	9808	—
.280 REM	14005	14034	14006	14035	14049	—	—
7MM REM MAG	13605	13634	13606	13635	13649	9809	—
7MM REM ULTRA MAG	17805	17834	17806	17835	17849	9809	—
7MM STW	26605	26634	26606	26635	26649	9809	—
7MM T/CU	34205	34234	34206	34235	34249	9809	—
7MM-08 REM	13905	13934	13906	13935	13949	9809	—
7MM BENCH REST	—	34134	34106	34135	34149	9809	—
.308 WINCHESTER	15505	15534	15506	15535	15549	9812	—
.30-06 SPRINGFIELD	14805	14834	14806	14835	14849	9812	—
.300 WSM	30805	30834	30806	30835	30849	9812	—
.300 REM ULTRA MAG	17605	17634	17606	17635	17649	9812	—
.300 WBY MAG	15205	15234	15206	15235	15249	9812	—
.300 WIN MAG	15305	15334	15306	15335	15349	9812	—
300 NORMA MAG	31505	—	—	31535	31549	—	9812
.30-378 WBY MAG	29505	29534	29506	29535	29549	9812	—
.338 LAPUA	16605	16634	16606	16635	16649	9818	—

GROUP A									
Caliber	Full-Length Die Set	Full-Length Sizer Die	Neck Die Set	Neck Sizer Die	Small Base Die Set	Small Base Sizer Die	Seater Die	Exp-Decap Unit	Trim Die
.17 REM	17201	—	17202	—	—	—	—	9882	—
.17 REM FIREBALL	16201	—	16202	—	—	—	—	9882	—
.204 RUGER	10301	10329	10302	10330	—	—	—	9801	—
.218 BEE	10001	—	—	—	—	—	—	9802	—
.22 HORNET	10201	—	10202	—	—	—	—	9802	—
.22-250 REM (.22 VAR.)	10601	—	10602	10630	—	—	—	9802	—
.220 SWIFT	10701	—	10702	—	—	—	—	9802	—
.221 REM FIREBALL	10801	—	10802	—	—	—	—	9802	—
.222 REM	10901	—	10902	10930	+	+	—	9802	—
.222 REM MAG	11001	—	—	—	—	—	—	9802	—
.223 REM (5.56MM)	11101	11129	11102	11130	11103	11131	11138	9802	11165
.223 WSSM	10501	—	10502	—	—	—	—	9800	—
.240 WBY MAG	33201	—	—	—	—	—	—	9805	—
.243 WIN	11401	11429	11402	11430	11403	11431	—	9805	—
.243 WSSM	11601	—	11602	—	—	—	—	9805	—
6MM REM (.244 REM)	11501	—	11502	—	—	—	—	9805	11565
6MM PPC	22601	—	—	—	—	—	—	—	—
.25-06	12001	—	12002	12030	+	+	—	9806	12065
.25 WSSM	12401	—	12402	—	—	—	—	9806	—
.25-20 WIN	11801	—	—	—	—	—	—	9806	—
.25-35 WIN	12101	—	—	—	—	—	—	9806	—
.250 SAV (.250-3000 SAVAGE)	12201	—	—	—	+	+	—	9806	—
.257 ROBERTS	12501	—	12502*	—	—	—	—	9806	—
.257 WBY MAG	12601	—	12602*	—	—	—	—	9806	—
6.5MM CREEDMOOR	32901	—	—	32930	—	32931	32938	9807	—
.260 REM	12801	—	12802	12830	—	—	—	9807	—
.264 WIN MAG	12701	—	12702*	—	—	—	—	9807	—
6.5X55 SWEDISH MAUSER	13201	—	13202	13230	—	—	—	9807	—
6.8 REMINGTON SPC	13301	—	—	—	13303	—	—	9808	—
.270 WBY MAG	13401	—	13402*	—	—	—	—	9808	—
.270 WIN	13501	—	13502	13530	13503	—	—	9808	—
.270 WIN SHORT MAG	31301	—	31302*	—	—	—	—	9808	—
.280 REM (7MM EXP REM)	14001	—	14002*	—	—	—	—	9809	14065*
.284 WIN	14101	—	14102	—	+	+	—	9809	—
7MM REM MAG	13601	—	13602	13630	13603	—	—	9809	—
7MM REM SA ULTRA MAG	31101	—	31102*	—	—	—	—	9809	—
7MM REM ULTRA MAG	17801	—	17802	—	—	—	—	9809	—
7MM STW	26601	—	26602	—	—	—	—	9809	—
7MM T/CU	34201	—	34202	—	—	—	—	—	—
7MM WBY MAG	13701	—	13702	—	—	—	—	9809	—
7MM WIN SHORT MAG	31401	—	31402*	—	—	—	—	9809	—
7MM-08 REM	13901	—	13902	13930	+	+	—	9809	—
7X57 MAUSER (7MM MAUSER)	13801	—	13802	—	—	—	—	9809	13865
7MMX64 BRENNERKE	34001	—	34002*	—	—	—	—	9809	34065*
7-30 WATERS	34801	—	34802*	—	—	—	—	9809	34865*
7.5MM SCH-RUBIN (1911)	33501	—	33502	—	—	—	—	9812	—
7.62X54R RUSSIAN	29001	—	29002*	29030*	—	—	—	***	—
7.62MMX39-.308/311	35001	—	—	—	—	—	—	**	—
7.65MMX53 BELGIUM MAUSER	14301	—	—	—	—	—	—	9814	—
7.7MMX58 JAPANESE ARISAKA	14401	—	14402	—	—	—	—	9814	—
.30 LUGER (7.65MM LUGER)	25001	—	—	—	—	—	—	9813	—
.30 T/C	25201	—	—	—	—	—	—	9812	—
.30-06 SPRINGFIELD	14801	14829	14802	14830	14803	14831	—	9812	—
.30-30 WIN	14601	—	14602*	—	—	—	—	9812	—
.30-378 WBY MAG	29501	—	29502	—	—	—	—	9812	—
.30-40 KRAG	14701	—	—	—	—	—	—	9812	—
.300 RCM	26901	—	26902	—	—	—	—	9812	—
.300 REM SA ULTRA MAG	31201	—	31202*	—	—	—	—	9812	—
.300 REM ULTRA MAG	17601	—	17602	17630	—	—	—	9812	—
.300 SAVAGE	15101	—	—	—	—	—	—	9812	—
.300 WBY MAG	15201	—	15202	—	—	—	—	9812	—
.300 WIN MAG	15301	15329	15302	15330	15303	—	—	9812	—

RELOADING DIES

GROUP A (CONTINUED)									
Caliber	Full-Length Die Set	Full-Length Sizer Die	Neck Die Set	Neck Sizer Die	Small Base Die Set	Small Base Sizer Die	Seater Die	Exp-Decap Unit	Trim Die
.300 WIN SHORT MAG	30801	—	30802*	—	—	—	—	9812	—
.303 BRITISH	15401	—	15402	15430	—	—	—	9814	—
.308 MARLIN EXPRESS	14901	—	—	—	—	—	—	9812	—
.308 WIN / .307 WIN	15501	15529	15502	15530	15503	15531	15538	9812	15565
8MMX57 MAUSER (8MM MSR)	15901	—	15902	15930	—	—	15938	9817	15965
8MM REM MAG	16001	16029	—	—	—	—	—	9817	—
.32 WIN SPEC	15701	—	—	—	—	—	—	9816	—
.325 WIN SHORT MAG	31601	—	31602	—	—	—	—	9817	—
.338 RCM	27301	—	27302	—	—	—	—	9828	—
.338 Marlin Express	25401	—	—	—	—	—	—	9818	—
.338 FEDERAL	17301	—	17302	—	—	—	—	9828	—
.338 REM ULTRA MAG	17701	—	17702*	—	—	—	—	9818	—
.338 WIN MAG	16301	—	16302	—	—	—	—	9818	—
.338 LAPUA	16601	16629	16602	16630	—	—	—	9818	—
.338-378 WBY MAG	16801	—	—	—	—	—	—	9818	—
.340 WBY MAG	30601	—	—	—	—	—	—	9818	—
.35 REM	16501	—	—	—	+	+	—	9820	—
.35 WHELEN	30701	—	—	—	—	—	—	9823	—
.357 SIG	23101	—	—	—	—	—	—	9834	—
.358 WIN/.356 WIN	32701	—	—	—	—	—	—	9823	—
9.3MMX62 MAUSER	34501	—	34502	—	—	—	—	9821	—
.375 H&H MAG	16901	—	16902*	—	—	—	—	9822	—
.375 REM ULTRA MAG	30901	—	30902*	—	—	—	—	9822	—
.375 RUGER	26801	—	26802	—	—	—	—	9822	—

*If not in stock, please allow 4-6 weeks for delivery. **A .30 caliber Expander Ball is also included with Die Set and Sizer Die. ***A .310 caliber Expander Ball is also included with Die Set and Sizer Die. +See the RCBS Special Catalog for this item.

GROUP B												
Caliber	3-Die Carbide Roll Crimp Set	3-Die Carbide Taper Crimp Set	3-Die Roll Crimp Set	3-Die Taper Crimp Set	Carbide Sizer Die	Steel Sizer Die	Expander Die	Roll Crimp Seater Die	Taper Crimp Seater Die	Decap Unit	Trim Die	
.32 AUTO (1)	—	20015	—	—	—	—	—	—	20062	9622	—	
.357 MAG/.357 REM MAX/.38 SPL	18212	18215	—	—	18237	—	—	18342	18262	9622	—	
9MM LUGER/9X21/356 TSW/9X23 WIN/9X18 ULTRA	—	20515	—	—	20537	—	—	—	20562	9622	—	
.380 AUTO	—	20415	—	—	—	—	—	—	—	9622	—	
.40 S&W/10MM AUTO	—	22115	—	—	—	—	—	—	22162	9622	—	
.41 MAG	18512	—	—	—	—	—	—	—	—	9622	—	
.44 MAG/.44 SPL	18612	—	18608	—	18637	—	—	18742	18662	9622	—	
.44-40 WIN (3)	—	—	18805	—	—	—	—	—	—	9622	—	
.44-.40 WIN JACKETED (4)	—	—	18806	—	—	18832	—	—	—	9622	18865*	
.45 AUTO(ACP)/AUTO RIM/GLOCK ACT. PISTOL	—	18915	—	—	18937	—	—	18942	18962	9622	—	
.45 COLT	19112	—	19108	—	—	—	—	—	—	9622	—	
.460 S&W	24212	—	—	—	—	—	—	24238	—	9622	—	
.454 CASULL	23212	—	—	—	—	—	—	23242	—	9622	—	
.480 RUGER/.475 LINEBAUGH 1.400"	35212	—	35208	—	—	—	23553	—	—	9622	—	
.50 ACTION EXPRESS	—	—	—	22210	—	—	—	—	22262	9622	—	
.500 S&W/.500 S&W SPL	23812	—	23808	—	—	—	—	23838	—	9622	—	

*May not be available from stock. 1: For use with .311" bullets. 2: For use with .314" bullets. 3: Regular Seater Die for all lead and jacketed bullets from Hornady, Sierra and Speer. 4: Jacketed Seater Die for Remington bullets only. **Not for use with .45 Auto Rim or .45 GAP.

GROUP C							
Caliber	3-Die Carbide Taper Crimp Set	3-Die Roll Crimp Set	3-Die Taper Crimp Set	Expander Die	Taper Crimp Seater Die	Decap Unit	Trim Die
.30 M-1 CARBINE	18015	—	18010	—	—	9622	—
.375 WIN	—	20604	—	—	—	9619	—
.444 MARLIN	—	20704	—	—	—	9619	—
.45-70 US GOV'T	—	20904	—	—	—	9619	20965*
.450 MARLIN	—	35504	—	—	—	9619	—
.450 BUSHMASTER	—	—	NEW 21604	—	NEW 21662	—	—
.458 WIN MAG	—	20804	—	—	—	9619	—
.458 LOTT	—	24104	—	20858	—	9619	—

*May not be available from stock.

GROUP D								
Caliber	Full-Length Die Set	Neck Die Set	Neck Sizer Die	Small Base Die Set	Small Base Sizer Die	Exp-Decap Unit	Trim Die	Decap Assy
.17 HORNET	21801	—	—	—	—	—	—	—
.22 K-HORNET	26201	—	—	—	—	9802	—	—
.22 REM JET	10401	—	—	—	—	9800	—	—
.22 SAVAGE HI POWER	33801	—	—	—	—	9803	—	—
.22 NOSLER	29701	—	—	—	—	9802	—	—
.224 VALKYRIE	11201	—	—	—	11231	—	—	9802
5.6MMX50 RIMMED	26301	—	—	—	—	9802	—	—
5.7 x 28 (FN)	11701	—	—	11703	—	9802	11765 ^{AA}	—
.257 ROBERTS IMP 40	32201	—	—	—	—	9806	—	—
6MMX45	28901	—	—	—	—	9805	—	—
26 NOSLER	26501	—	—	—	—	9807	—	—
264 LBC-AR	16401	—	—	—	—	9807	—	—
6MM CREEDMOOR	31801	—	—	—	NEW 31831	—	—	9805
27 NOSLER	26401	—	—	—	—	9808	—	—
.280 ACKLEY IMPROVED	17001	—	—	—	—	9809	—	—
28 NOSLER	27401	—	—	—	—	9807	—	—
6.5 RSAUM	31901	—	—	—	—	—	—	9806
6.5MM PRC	32101	—	—	—	—	—	—	9806
6.5MM-06	27801	—	—	—	—	9807	—	—
6.5-300 WBY	31701	—	—	—	—	9807	—	—
6.5MM REM MAG.	33401	—	—	—	—	9807	—	—
6.5MM-284 WIN	28701	—	—	—	—	9807	—	—
6.5MMX47 LAPUA	12901	12902	—	—	—	9807	—	—
6.5MMX54 MANNLICHER-SCHOEN.	27701	—	—	—	—	9807	—	—
6.5MMX57 MAUSER	32801	—	—	—	—	9807	—	—
6.5MMX68S	27901	—	—	—	—	9807	—	—
7MM B R REM	34101	—	—	—	—	9809	—	—
7MMX65 RIMMED	26701	—	—	—	—	9809	—	—
.30 MAUSER (7.63MM MAUSER)	25101	—	—	—	—	9813	—	—
.30 REM	29201	—	—	—	—	9812	—	—
30 NOSLER	29250	—	24251	—	—	9812	—	—
.30 REM AR	25301	—	—	—	—	9812	—	—
.300 AAC BLK	22401	—	—	—	—	9812	—	—
.30-338 WIN MAG	29401	—	—	—	—	9812	—	—
.300 H&H MAG	15001	—	—	—	—	9812	—	—
300 NORMA MAG	31501	—	—	—	—	—	—	9812
.308 NORMA MAG	15601	—	—	—	—	9812	—	—
7.5MMX54 FRENCH MAS	29101	—	—	—	—	9832	—	—
.32-40 WIN	32501	—	—	—	—	9816	—	—
8MM-06	32601	—	—	—	—	9817	—	—
8MMX68S MAGNUM	34401	—	—	—	—	9817	—	—
.33 NOSLER	29301	—	—	—	—	—	—	—
.338-06/ 338-06 A-SQUARE	16701	—	—	—	—	9828	—	—
.338 NORMA MAG	13001	—	—	—	—	9828	—	—
.348 WIN	33601	—	—	—	—	—	—	—
.350 REM MAG	33701	—	—	—	—	9820	—	—
.370 SAKO MAG/9.3X66	14201	—	—	—	—	9821	—	—
9.3MMX74 RIMMED	34601	—	—	—	—	9821	—	—
.376 STEYR	—	—	—	—	—	9822	—	—
.378 WBY MAG	33001	—	—	—	—	9822	—	—
.400 CORBON	—	—	—	—	—	—	—	—
.416 RUGER	13101	—	—	—	—	9827	—	—
.416 REM MAG	22701	—	—	—	—	9827	—	—
.416 RIGBY	22801	—	—	—	—	9825	—	—
.460 WBY MAG	33101	—	—	—	—	9826	—	—

*If not in stock, allow 4-6 weeks for delivery. ^Includes extended shell holder.

GROUP E						
Caliber	3-Die Carbide Taper Crimp Set	3-Die Carbide Roll Crimp Set	3-Die Roll Crimp Set	Roll Crimp Seater Die	Decap Unit	
.25 AUTO (.25 ACP)	21015	—	—	—	—	—
.327 Fed/.32 S&W L/H&R MAG	21415	21412	—	—	—	9622
.32-20 WIN	—	—	18105	—	—	9622
9MM FAR	—	—	—	—	—	9622
9MM MAKAROV	23015	—	—	—	—	9622
.38 COLT SUPER AUTO/ACP	20215	—	—	—	—	9622
.38-40 WIN (†)	—	—	35605	—	—	9622

* May not be available from stock. ** 9mm FAR is a steel sizing die with taper crimp. 1: For use with lead bullets only. + Requires Extended Shell Holder, not included. Δ Not for use with .327 Fed Mag.

LEGACY SERIES DIES

With new calibers and rifles introduced every year, it is a wonder that black powder cartridges are still around! The Legacy series of dies supports these legendary metallic black powder cartridges and the enthusiasts that are shooting original or reproduction black powder rifles.

LEGACY SERIES DIES				
Caliber	3-Die Roll Crimp Set	Expander Die	Decap Unit	Trim Die
.38-55 WIN & BAL	36504	—	9619	—
.40-60 WIN (.408 BORE)	—	—	9619	—
.40-65 SHILOH SHARPS (.408 BORE)	23304	23358	9619	—
.40-70-2 1/2" SHARPS STRAIGHT	19204	—	9619	—
.405 WIN	23608	—	9619	—
.45-60 WINCHESTER	19804	20955	9619	—
.45-75 WINCHESTER	19904	20955	9619	—
.45-90-2.4" SHARPS STRAIGHT	19304	20858	9619	—
.45-100-2.6" SHARPS STRAIGHT	19404	20858	9619	—
.45-110-2 7/8" SHARPS STRAIGHT	19504	20858	9619	—
.45-120-3 1/4" SHARPS STRAIGHT	19604	—	9619	—
.50-70 GOV'T	36804	36858	9619	—
.50-90-2 1/2" SHARPS STRAIGHT	19704	—	9619	—
.50-95 WINCHESTER EXPRESS	21304	19758	9619	—
.56-50 SPENCER	20104	—	9619	—

RELOADING DIES



D COWBOY DIES

Cowboy Action Shooting is one of the fastest growing shooting sports. Shooters must have speed and accuracy, while recreating the spirit of the 1880s. Guns, costumes and ammo must fit the period. Making ammo that fits the Old West image means loading lead bullets, jacketed bullets are not allowed. It also means that the bullets must be designed to work properly in lever-action rifles and single-action revolvers. RCBS' Cowboy Dies are built to slightly different dimensions than our regular dies to allow optimum sizing, expanding, seating and crimping needed to load great lead bullet ammo.

COWBOY DIES						
Caliber	3-Die Full-Length Set	3-Die Roll Crimp Set	3-Die Carbide Roll Crimp Set	Expander Assembly	Seater Plug	Decap Unit
.25-20 WIN	11850	—	—	—	—	—
.30-30 WIN	14650	—	—	—	—	9628
.32 S&W LONG/ .32 S&W	—	—	21451	—	—	9628
.32 WIN SPL	15750	—	—	9904	—	9628
.32-20 WIN	—	18151	—	—	—	9628
.32-40 WIN	32550	—	—	9904	90084	9628
.357 MAG/.38 SPL	—	—	18251	9906	—	9628
.38 S&W	—	20351	—	9906	—	9628
.38-40 WIN	—	35651	—	—	90087	9628
.38-55 WIN	—	36551	—	—	—	9628
.40-65 WIN .410" BORE	—	36651	—	—	—	9628
.44 S&W RUSS/ .44 SPL	—	—	18651	—	—	9628
.44-40 WIN	—	18851	—	—	—	9628
.45 S&W SCHO/ .45 COLT	—	—	19151	—	—	9628
.45-70 US GOV'T	—	20951	—	—	—	9628

E 1-1/2"-12 DIES

The dies are precision machined by the same craftsmen that produce our Precisioneered® Reloading Dies. The Full Length Sizer Die is drilled and reamed to the dimensions developed over the years. Then each die is hand polished, heat treated and then repolished. These massive dies are designed for use with the AmmoMaster—2 or the AmmoMaster® Single Stage Press with the .50 BMG Conversion Kit installed. All Dies listed here are manufactured with 1-1/2"-12 thread. Full Length Die Set includes Full Length Sizer Die with Expander-Decapping Unit and Seater Die with Bullet Seater Plug. Trim Die is case hardened to prevent damage to the die when filing cases to length. Neck Sizer Die sizes only the neck, not the shoulder and body.

SEAT PLUG ASSEMBLIES — .50 BMG	
Caliber	
Seat Plug Assy .50 BMG A-Max (5/8-18)	90093

F SAFARI DIES

Straight out of the RCBS® Special Order and listed at a reduced price. The Safari Series represents cartridges typically used for dangerous game in Africa. These featured calibers were chosen based on production rifles from CZ®, Ruger® and others that offer these timeless African hunting classics.

The .500 Jeffery and .505 Gibbs are made on 1" die bodies and require a press adapter bushing (not included).

SAFARI DIES				
Caliber	Full-Length Die Set	3-Die Roll Crimp Set	3-Die 1" Roll Crimp Set	Decap Unit
.404 JEFFERY	24301	—	—	—
.450 x 400 EXPRESS 3" (.400 JEFFERY)	24401	—	—	9804
.450 RIGBY RIMLESS	23001	—	—	—
.470 NITRO EXPRESS 3-1/4"	24601	—	—	—
.500 JEFFERY	—	—	24704*	9619
.500 NITRO EXPRESS 3"	—	24804	—	9619
.505 GIBBS	—	—	24904*	9619

*Requires 1" press adapter bushing, not included. NOTE: RC Supreme comes standard with a 1-1/4"-12 to 7/8"-14 press bushing adapter.

RELOADING DIES



G AR SERIES DIES

A must for the progressive reloader. It features a Small Base sizing die and a new Taper Crimp seating die. This combination makes reloading easier for AR-style or semi-auto shooters. The Small Base sizer guarantees that the cartridge will rechamber. The Taper Crimp Seater is more forgiving when various case lengths are loaded at the same time. Case neck crimp bulges and buckled shoulders are virtually eliminated when Taper crimping is used with cannelured bullets.

AR DIES		
Caliber	Small Base Die Set	Taper Crimp Seater Die
.204 RUGER	10307	—
.223 REM./5.56MMx45	11107	11162
.22 NOSLER	29707	—
6MMx45	28907	—
.224 VALKYRIE	11207	—
.243 WIN.	11407	—
.264 LBC-AR	16407	—
6.5 CREEDMOOR	32907	32962
.260 REM.	12807	—
6.8MMx43 REM. SPC	13307	—
7.62MMx39	35007	—
.308 WIN.	15507	15562
.30 REM. AR	25307	—
.300 AAC BLK	22407	22462
.30-06 SPRINGFIELD	14807	14862
.338 FEDERAL	17307	—

H COMPETITION RIFLE DIES

These dies aren't for everybody. They go above and beyond our Precision Dies. If you're a competitive marksman measuring success in fractions of a millimeter, RCBS® Competition Dies are for you.

NOTE: Competition dies do not require neck bushings.

- Full-length sizer with a raised expander ball allowing extra leverage for smooth, effortless neck expansion (.204 and .25 cal do not feature a raised expander ball)
- Maximum concentricity between die neck and body
- Seater die with micrometer for super accurate bullet seating depth in increments of 0.001"
- Bullet inserts through a side window instead of bottom of die
- Special bullet-seating guide ensures correct bullet alignment before and after seating
- Extended shell holder for shorter cartridges
- Black oxide finish
- Not for use with progressive reloading presses

COMPETITION DIES

Caliber	Competition Full-Length Die Set	Competition Full-Length Sizer Die	Competition Seater Die	Competition Extended Shell Holder	Decap-ping Pin	Competition Seater Plug Assembly	Competition Bullet Guide
.204 RUGER	39401+	39429	39438+	38260	9608	38150	38201
.22 HORNET	38301+	38329	38338+	38262	—	38151	38202
.222 REM	37001+	37029	37038+	38260	9608	38151	38202
.223 REM	37201+	37229	37238+	38260	9608	38151	38202
.22-250 REM	37101+	37129	37138+	38253	9608	38151	38202
.243 WIN	37301+	37329	37338+	38253	9608	38152	38205
.25-06	39501	39529	39538	—	9609	—	38206
6.5MMX55 SWEDISH MAUSER	38401+	38429	38438+	38252	9609	38154	38207
.270 WIN	37501	37529	37538	—	9609	38155	38208
7MM-08 REM	37401+	37429	37438+	38253	9609	38156	38209
7MM REM MAG	37601	37629	37638	—	9609	38156	38209
7MMX64 BRENEKE	38501	38529	38538	—	9609	38156	38209
7.5MMX55 SCHMIDT-RUBIN	38601	38629	38638	—	9609	38157	38212
.30-06 SPRINGFIELD	37701	37729	37738	—	9609	38157	38212
.308 WIN	37801+	37829	37838+	38253	9609	38157	38212
8MMX57 MAUSER	38701	38729	38738	—	9609	—	—

+Competition extended shell holder required for bullet seating is included.

*Current "O" ring style only.

RELOADING DIES



I COWBOY SHOTSHELL DIE

The diehard Cowboy Action Shooter not only uses authentic firearms and loads with black powder, but also dresses the part. Many would like to use period correct all brass shotshell ammunition, but with no good way to reload them, colorful plastic hulls continue to be used. Today's modern shotshell presses can handle the powder drop, wad seating and shot drop, but could do nothing to handle the sizing, de-priming, re-priming and crimp of a brass case. The RCBS® Cowboy Shotgun die answers this need.

Designed to be used in any RCBS single stage press with a removable die bushing, it performs just like a rifle sizing die. The Cowboy Shotgun Die will first size and de-prime the case; Re-priming is done with the standard priming provided with the press. Use your shotshell press to fill the case with powder, seat the wad and spacers and dispense your shot charge. Remove the sizing ring and install the finish crimp. Place your over shot card onto the shot charge and run up into the die to roll crimp the case mouth. A newly handloaded brass shotshell is completed.

- 99060 COWBOY SHOTSHELL DIE
- 99061 12 GA SHELL HOLDER - BRASS CASE

J X DIE®

Trim the case once—never trim again! The X-Sizer Die looks like a regular Full Length Sizer Die. Inside, the die features a specially designed mandrel with an expander ball and decapping pin attached. The mandrel is what the X-Die® is all about. The patented X-Sizer Die eliminates the need for repeated trimming after an initial trim of .020" off the maximum case length to standardize the case. The X-Die doesn't shorten the length of the case: the mandrel reduces the growth rate as the case grows as a result of the case mouth-contacting the mandrel during sizing. Because of an extremely close tolerance between the mandrel and die neck wall, the neck wall of the case does not thicken as the case length is pushed back. Cases repeatedly sized in the X-Die will initially grow a few thousandths of an inch, then stabilize below the maximum case length with no discernable loss of accuracy or case life.

Available in most popular bottleneck calibers as shown in the chart.

Standard 7/8"-14 thread. U.S. Patent # 5635661

If you are just starting to reload any of the calibers listed, order the X-Full Length Die Set containing the X-Sizer Die and Standard Seater Die. If you already own a regular set of dies for the chosen caliber, order only the X-Full Length Sizer Die, as you won't need to purchase another Seater Die.

X DIE CHART

Caliber	X Full-Length Die Set	X Full-Length Sizer Die	X Mandrel Assembly
.22-250 REM	37112	-	-
.223 REM	37212	37109	37214
.223 REM SMALL BASE	38862	38859	37214
.243 WIN	37312	-	-
.25 WSSM	12412	12409	12414
.25-06	38962	-	-
.260 REM	39012	-	-
6.5MMX55 SWEDISH MAUSER	38412	-	-
.270 WIN	37512	-	-
.280 REM	39062	-	-
7MM REM MAG	37612	-	-
7MM-08 REM	37412	-	-
.30-06 SPGFLD	37712	-	-
.30-06 SPGFLD SMALL BASE	-	39159	37714
.30-30 WIN	37912	-	-
.300 REM ULTRA MAG	17612	-	-
.300 WBY MAG	39212	-	-
.300 WIN MAG	38912	-	-
.300 WIN SHORT MAG	30812	-	-
.308 WIN	37812	37809	-
.308 WIN SMALL BASE	39262	39259	37814
8MMX57 MAUSER	-	38709	-
.338 WIN MAG	39312	-	-

ALTERNATE SEATER PLUGS (SPECIAL APPLICATION)

These through-the-top seater plugs (1/2" - 20 thread) are available separately and manufactured to fit bullets shown in the chart below. They are not furnished with the die sets or seater dies. Seater plugs with 1/4" - 28 thread design, are for use with older RCBS® dies and can be made on a special order basis. Call or write RCBS for information.

ALTERNATE SEATER PLUGS — 1/2"-20	
357 Cal 180 gr. Silhouette	90019
38 Cal. 125 gr. Gold Dot	90065
9mm Cal. 90 gr. Gold Dot	90060
9mm Cal. 115 gr. Gold Dot	90061
9mm Cal. 124 gr. Gold Dot	90062
9mm Cal. 147 gr. Gold Dot	90063
40/10mm 155 gr. Gold Dot	90067
40/10mm 165 gr. Gold Dot	90074
40/10mm 180 gr. Gold Dot	90068
10mm Round Nose	90039
40-Cal 400 Black Powder	90042
44 Cal. 240 gr. Silhouette	90031
44 Cal. 270 gr. Gold Dot	90075
44/45 SWC	90033
45 Cal. 200 gr. Barnes XPB	90034
45 Cal. 230 gr. Gold Dot	90070
45 Cal. 500 gr. Black Powder Silhouette	90080

SMALL BASE DIE SETS (GROUP A)

Small Base Sizer Dies are usually required for reloading ammunition to be used in automatic, semi-automatic, pump, slide and some lever-action rifles. These dies size the body of cases somewhat smaller in diameter and also set the shoulder back slightly more than a Full-Length Sizer Die to ensure proper functioning in the actions of these rifles.

Not recommended for ammunition used in bolt-action rifles. Small Base Set contains Small Base Sizer with Expander-Decapping Unit and Regular Seater Die with Seater Plug. Small Base Sizer Dies also available individually. Available in many calibers.

See listings on pages 47-48

DECAPPING PINS — 5-PACK	
6mm PPC	9608
7mm Thompson Center Ugalde	9609
35 Whelen	9609
357 SIG	9608
358 Winchester/356 Winchester	9609
416 Remington Magnum	9609

DECAPPING PINS — 5-PACK	
Universal - Headed 22 thru 45 caliber	90164
Small - Straight 22 thru 25 caliber	9608
Large - Straight 6.5mm thru 45 caliber	9609

Important: Expander-Decapping Units, Decapping Units and all Decapping Pins are available through RCBS Distributors and Dealers. All other replacement parts should be ordered from RCBS Customer Service.

REPLACEMENT DECAPPING PINS

With the few exceptions listed above, all RCBS® "Precision," Reloader Special, X and Cowboy Sizer Dies require a #90164 headed Decapping Pin—one size fits all calibers. Order straight Decapping Pins for Competition and older "Precision" Sizer Dies.

Pow'r Punch Decap Assembly for use with pistol calibers in progressive presses.

REPLACEMENT PARTS

Expander-Decapping Rods, Decapping Rods, Expander Balls and Decapping Pin Holders are no longer available separately. If any of these fail, order a replacement Expander-Decapping Unit or Decapping Unit as shown in the tables.

SPECIAL ORDER SETS

If you cannot find your dies listed on the reference chart on pages 40-41 of this catalog, please consult the RCBS Special Order catalog.

See charts on following pages for part numbers.

*Competition extended shell holder required for bullet seating is included.

NOTE: If not in stock, allow 4-6 weeks for delivery.

SPECIAL ORDER



Special Order Reloading Dies are assigned to pricing groups depending on the number of dies per set, special components, and time required to manufacture. If the desired caliber is out of stock, please allow 30 - 45 days for delivery.

SPECIAL ORDER

RCBS® Precisioneered® Dies begin and end with PEOPLE! Experienced people. Patient people. And rarest of all in today's hurry-up rush-it-out world, people who still take great pleasure and pride in doing a better job than the next guy. From machine operators to hand finishers, each is responsible for providing you with the world's finest dies—RCBS Precisioneered Dies.

RCBS special order dies and case forming dies, like all RCBS dies, are produced in our own plant by the most experienced die craftsmen in the industry. The dies are machined, hardened, hand-finished and hand-inspected for precision and quality. All products in this category carry the RCBS limited lifetime warranty.

With the exception of the Group X Dies®, all reloading and case forming dies are manufactured with the standard 7/8"-14 thread, and may be used with most reloading presses. Group X Dies are manufactured with a 1"-14 thread for use only in the RCBS AmmoMaster™-Single, Big Max, Rock Chucker™, Rock Chucker

When ordering Group X Dies you must specify RCBS press model so the proper adapter bushing can be supplied.

All special order items in this catalog may be ordered through your RCBS Dealer. Or, you may order direct from the RCBS factory. All factory orders must be paid in advance of shipment and are not subject to cancellation or return for credit. Payment may be made by check or money order in U.S. funds or your order may be charged to your Visa or MasterCard account. Due to bank collection fees, international orders (except Canada) must be paid by MasterCard or Visa only. Sorry, no C.O.D. shipments. Be sure to include your daytime phone number in case we need to contact you concerning your order.

Shipping and handling: \$0.01-\$20.00 = \$4.50, \$20.01-\$100.00 = \$7.50, \$100.01-\$200.00 = \$11.50, \$200.01-up = \$16.50 (Domestic U.S. only). UPS Next Day Air and 2nd Day Air are available. Call for more information. International consumer direct orders will be shipped via UPS or FedEx International ONLY.

Supreme, Reloader Special—3 and 5, Model A-2, or Model A-3 presses.

CUSTOM RELOADING & CASE FORMING DIES

RCBS no longer produces unique, one-of-a-kind, custom dies or custom bullet moulds. RCBS still offers special order die sets and case form sets in the special order catalog. RCBS offers many reloading die sets and case form sets which are not listed in this catalog. For more information, email rcbs.tech@vistaoutdoor.com or call 800-379-1732.

A

Riser Stand Shown
Not Included



A

THE GRAND

Designed for the shotgunner who requires accurate, precision shotshells for hunting or clay target shooting. Start a hull at station 1 and insert a wad in the wad guide at station 4. All other functions are performed automatically by The Grand. Once in full operation, a loaded shotshell is dispensed each time the handle is cycled through the full down and up strokes. The case-activated Powder System means no hull, no powder dropped and therefore no spillage, and there is no need to manually turn the powder on and off. Located at the front of the press, the powder charging station makes it easy to view the powder charge and conveniently remove the powder-charged hull for weighing the powder charge, if necessary. The Powder System provides three positions for the Powder Measure: "ON", "OFF", and "EMPTY". To completely empty the powder hopper, attach the drain tube and turn the powder measure to "EMPTY". The powder will then drop back into the powder can at the bottom of the drain tube. Powder Bushings easily interchange in about 30 seconds, and are available for all popular loads. Hornady® Powder Bushings may also be used in The Grand charge bar. Powder Hopper fits 1 lb. of your favorite smokeless powder.

The Shot System is also case-activated, quick and simple. No hull/wad, no shot and best of all, no spillage. No need to continually turn the shot measure "ON" or "OFF". The shot system is easily drained. Attach the drain tube below the shot measure. Shift the Shot Measure to "EMPTY". Shot then falls back in the shot bag or container. Shot Bushings easily interchange in about 30 seconds, and are available for most popular charge weights and shot sizes. Hornady® Shot Bushings may also be used with The Grand charge bar. Shot Hopper capacity is 25 lbs. Through the unique combination of the Powder System, Shot System and Universal Case Holders, the user can load just one hull at a time without the fear of spilling powder or shot. Conversion Kits are available for changing to 12- or 20-gauge as required. These make the changeover quick and easy. Everything you need to make the changeover is included. U.S. Patent No. 6,772,668.

⚠ NOTE: Not for use with black powder. NOTE: See page 56 for Shot & Powder Bushing information.

89001 THE GRAND – 12 GAUGE

89003 THE GRAND – 20 GAUGE

BULLET CASTING



A



C

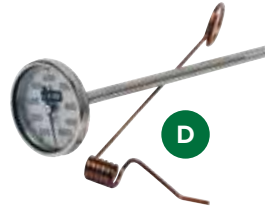

D



E



B



F

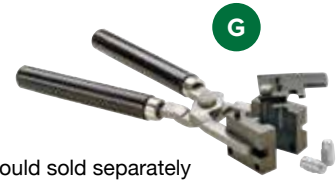

G

Mould sold separately

A PRO-MELT™ 2

The improved RCBS® Pro-Melt™-2 lead furnace is a necessity for those who love to cast lead bullets. The 25-pound capacity can mould hundreds of projectiles. The programmable temperature control has a digital readout to ensure accuracy, and the bottom-pour design ensures accurate, safe casting. If the first step of handloading is manufacturing bullets, the Pro-Melt™-2 is a necessity.

- 81099 PRO-MELT™ 2 FURNACE 120 VAC US/CAN**
- 81199 PRO-MELT™ 2 FURNACE 240 VAC INTERNATIONAL**

B EASY-MELT™

The new RCBS® Easy-Melt™ lead ladle pot is a necessity for those who love to cast lead bullets with a traditional ladle. The pot's 25-pound capacity is enough to cast hundreds of projectiles. The programmable temperature control has a digital readout to ensure accuracy. A hinged cover warms moulds while keeping out debris. The Easy-Melt lead ladle pot is a traditional option for those who love to manufacture bullets.

- 81098 EASY-MELT™ LADLE POT 120 VAC US/CAN**
- 81198 EASY-MELT™ LADLE POT 240 VAC INTERNATIONAL**

C LEAD POT

This heavy-duty cast-iron pot holds up to 10 pounds of molten metal. It features a flat bottom for stability, bail handle, pouring spout, and a tab lifter for gripping with insulated tongs or pliers.

- 80010 LEAD POT**

D LEAD THERMOMETER

With a 1000°F range and +/- 1% accuracy, our lead thermometer lets you pour lead at the optimum temperature. Large numbers are printed on a 1-1/2", glass-covered face. Six inch probe works with RCBS® Pro-Melt™, Pro-Melt 2™, Easy Melt™, or Lead Pot. An adjustable 6" handle helps to prevent burning your fingers.

- 81175 LEAD THERMOMETER**

E INGOT MOULD

Mould up to four ingots at once and cool them quickly with this handy accessory. It's perfect for melting down scrap lead and preparing alloys for future use.

- 80005 INGOT MOULD**

F LEAD DIPPER

A large-capacity bowl for easy scooping and stirring. The lead dipper has a tapered pouring spout to fit sprue holes and has a solid hardwood grip. Overall length: 11-1/2 inches.

- 80015 LEAD DIPPER**

G BULLET MOULD HANDLES

Solid steel frames with extra-long, premium hardwood handles for comfort. Perfect for home bullet casting. One size fits all RCBS® bullet moulds only. Mould pictured, sold separately.

- 80025 BULLET MOULD HANDLES**



WARNING

MELTING LEAD AND CASTING LEAD OBJECTS WILL EXPOSE YOU AND OTHERS IN THE AREA TO LEAD, WHICH IS KNOWN TO CAUSE BIRTH DEFECTS, OTHER REPRODUCTIVE HARM AND CANCER. SEE INSTRUCTIONS ON REDUCING EXPOSURE SUPPLIED WITH PRODUCT.

BULLET CASTING

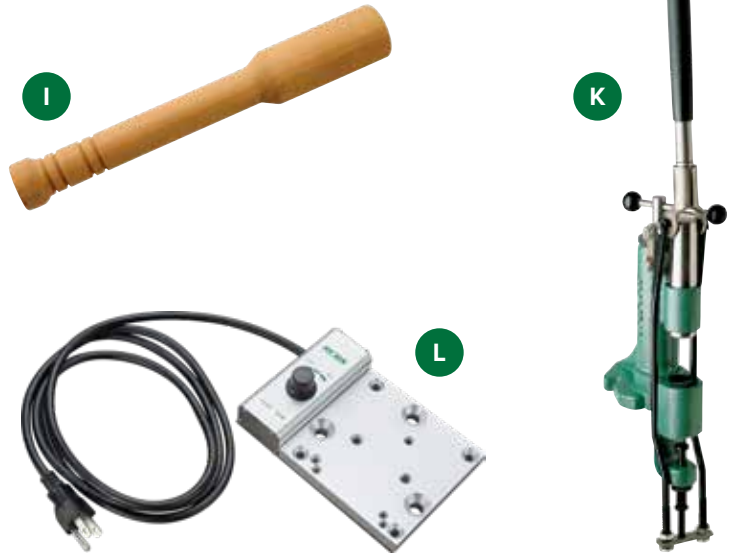

H NECK EXPANDER DIES FOR CAST RIFLE BULLETS

To eliminate deforming the base and shaving lead off the sides of your lead rifle bullets during seating, RCBS® strongly recommends using our Neck Expander Die. In one step, the neck expander die expands the neck and slightly flares the case mouth of your bottle neck cases.

- 39800 NECK EXPANDER BODY
- 39801 NECK EXPANDER PLUG ROD
- NECK EXPANDER PLUG (SEE CHART)

NECK EXPANDER DIES		
Bullet Diameter	Complete Die	Expander Plug Only
.224"	39803	39851
.228"	—	39853
.243"	39807	39855
.257"	39809	39857
.264"	39811	39859
.277"	—	39861
.284"	39815	39863
.308"	39817	39865
.309"	39819	39867
.310"	39821	39869
.311"	39823	39871
.321"	39825	39873
.323"	39827	39875
.338"	—	39877
.348"	39830	39878
.358"	39831	39879
.375"	39833	39881
.416"	39835	39883

I MOULD MALLET

Be kind to your bullet moulds. Stop using a metal object to tap out your cast lead bullets and potentially damaging your mould! RCBS® has reintroduced our wooden mould mallet to safely accomplish this goal.

80007 MOULD MALLET

J BULLET LUBRICANT

RCBS® Bullet Lubricant fits the Lube-A-Matic Sizer/Lubricator and most others that use a hollow stick lubricant. It's a non-toxic, temperature resistant blend, developed in cooperation with top-rated competition cast-bullet shooters. Our rifle bullet lubricant is a blend of Alox and beeswax, formulated to NRA specifications. Works fine for pistol bullets. Rifle Lube for outdoor use only.

- 80008 BULLET LUBRICANT
- 80009 RIFLE BULLET LUBRICANT

K LUBE-A-MATIC®—2 BULLET SIZER/LUBRICATOR

Size and lubricate cast bullets in one step with the Lube-A-Matic—2. Just insert a bullet in the sizer die and pull the handle. A sized and lubricated bullet ejects on the upstroke. A fingertip regulator lets you fine-tune lubricant flow. The Lube-A-Matic—2 also seats gas checks. A high quality tool that's a "must-have" item for the serious bullet caster.

(Die and top punch sold separately.) See chart on pages 59-61 for sizer die and top-punch sizes.

- 80040 LUBE-A-MATIC—2
- 86880 DUST COVER

L LUBE-A-MATIC® (LAM) HEATER

Make bullet casting easier with the new Lube-A-Matic® (LAM) Heater. The LAM Heater helps keep bullet lube flowing, ensuring proper sizing and lubricating in less time. It mounts to RCBS® accessory base plates, and is compatible with RCBS® Lube-A-Matic® Sizers, as well as other leading lead bullet sizers. Fits RCBS, SAECO, Lyman and other lead bullet sizers.

80006 LAM HEATER 120 VAC US/CAN ONLY

BULLET CASTING

RIFLE BULLET MOULDS



Caliber	22	6mm	25	270	7mm	30	30	30
Mould Part Number	22-055-SP 82007	243-095-SP 82015	257-120-SP 82016	270-150-SP 82017	7mm-168-SP 82018	30-115-SP 82009	30-150-FN 82019	30-180-SP 82020
Sizer Die Part Number	.225" dia. 82240	.244" dia. 82202	.258" dia. 82204	.278" dia. 82206	.285" dia. 82209	.309" dia. 82212	.309" dia. 82212	.309" dia. 82212
Top Punch Part Number	#506 85506	#509 85509	#515 85515	#529 85529	#531 85531	#535 85535	#546 85546	#541 85541

RIFLE BULLET MOULDS



Caliber	30	7.62mm	310 Cadet	32	35	375, 38-55	38-55
Mould Part Number	30-180-FN 82014	7.62-130-SPL 82022	310-120-RN 82023	32-170-FN 82024	35-200-FN 82028	37-250-FN 82029	378-312-BPS 82090
Sizer Die Part Number	.309" dia. 82212	.309" dia. 82212	Bullet NOT SIZED	.321" dia. 82217	.358" dia. 82223	.376" dia. 82225	.378" dia. 82252
Top Punch Part Number	#546 85546	#554 85554	or Lubed	#550 85550	#565 85565	#570 85570	#608 85608

RIFLE BULLET MOULDS



Caliber	40	40	40	40	40	416	44-40
Mould Part Number	40-300-SP-CSA 82070	-	-	-	-	416-350-FN+ 82075	44-200-FN 82036
Sizer Die Part Number	.410" dia. 82226	.410" dia. 82226	.410" dia. 82226	.410" dia. 82226	.410" dia. 82226	.417" dia. 82246	.428" dia. 82244
Top Punch Part Number	#378 82520	#378 82520	#378 82520	#609 85609	#620 85620	#562 85562	#595 85595

RIFLE BULLET MOULDS



Caliber	11mm	45	45	45	45	45	45
Mould Part Number	44-370-FN+ 82093	45-300-FN 82051	45-325-FN-U 82045	45-405-FN+ 82053	45-500-FN+ 82054	45-500-BPS+ 82085	-
Sizer Die Part Number	.446" dia. 82253	.458" dia. 82236	.458" dia. 82236	.458" dia. 82236	.458" dia. 82236	.458" dia. 82236	.458" dia. 82236
Top Punch Part Number	#585 85585	#600 85600	#383 85583	#600 85600	#600 85600	#607 85607	#621 85621

* also .475 Linebaugh + single cavity mould

BULLET CASTING

PISTOL BULLET MOULDS



Caliber	32	32	32	380	9mm	9mm	9mm	9mm
Mould Part Number	32-077-RN 82021	32-098-WC 82060	32-098-SWC 82061	38-090-RN 82057	9mm-115-RN 82026	9mm-124-RN 82062	9mm-124-RN-TG 82063	9mm-124-CN 82027
Sizer Die Part Number	.311" dia. 82214	.314" dia. 82216	.314" dia. 82216	.356" dia. 82221	.356" dia. 82221	.356" dia. 82221	.356" dia. 82221	.356" dia. 82221
Top Punch Part Number	#465 82536	#445 82543	#444 82542	#311 82513	#115 82504	#401 82521	#115 82504	#402 82522

PISTOL BULLET MOULDS



Caliber	9mm	38/357	38/357	38/357	38/357	40/10mm	10mm	10mm
Mould Part Number	9mm-147-FN 82077	38-148-WC 82031	38-150-SWC 82032	-	38-158-SWC 82065	40-180-FN 82066	10mm-170-SWC 82067	10mm-200-SWC 82068
Sizer Die Part Number	.356" dia. 82221	.358" dia. 82223	.358" dia. 82223	.358" dia. 82223	.358" dia. 82223	.401" dia. 82245	.400" dia. 82243	.400" dia. 82243
Top Punch Part Number	#556 85556	#429 82529	#429 82529	#311 82513	#429 82529	#558 85558	#518 85518	#518 85518

PISTOL BULLET MOULDS



Caliber	41	44	44	44	44	44	45 Auto	45 Auto	45 Auto
Mould Part Number	41-210-SWC 82039	-	44-240-SWC 82042	-	44-250-K 82080	44-300-SWC 82079	-	-	45-201-SWC 82047
Sizer Die Part Number	.410" dia. 82226	.430" dia. 82229	.430" dia. 82229	.430" dia. 82229	.430" dia. 82229	.430" dia. 82229	.452" dia. 82233	.452" dia. 82233	.452" dia. 82233
Top Punch Part Number	#420 82541	#421 82527	#421 82527	#421 82527	#421 82527	#421 82527	#680 82545	#460 82534	#680 82545

PISTOL BULLET MOULDS



Caliber	45	45 Auto	45 Colt	45 Colt	45 Colt	45	480 Ruger*	50 AE	500 S&W
Mould Part Number	-	45-230-RN 82048	-	45-255-SWC 82050	45-270-SAA 82092	45-300-SWC 82083	476-400-SWC+ 82094	50-340-SWC+ 82087	-
Sizer Die Part Number	.454" dia. 82234	.452" dia. 82233	.454" dia. 82234	.454" dia. 82234	.454" dia. 82234	.452" dia. 82233	.476" dia. 82237	.500" dia. 82254	.500" dia. 82254
Top Punch Part Number	#552 85552	#374 82519	#190 82506	#424 82528	#424 82528	#424 82528	#638 85638	#611 85611	#639 85639

* also .475 Linebaugh + single cavity mould

WARNING: MELTING LEAD AND CASTING LEAD OBJECTS WILL EXPOSE YOU AND OTHERS IN THE AREA TO LEAD, WHICH IS KNOWN TO CAUSE BIRTH DEFECTS, OTHER REPRODUCTIVE HARM AND CANCER. SEE INSTRUCTIONS ON REDUCING EXPOSURE SUPPLIED WITH PRODUCT.

BULLET CASTING

SILHOUETTE BULLET MOULDS



Caliber	6.5	7mm	308	308	357	44
Mould Part Number	6.5-140-SIL 82149	—	308-165-SIL 82152	—	357-180-SIL 82154	—
Sizer Die Part Number	.265" dia. 82207	.285" dia. 82209	.309" dia. 82212	.309" dia. 82212	.358" dia. 82223	.430" dia. 82229
Top Punch Part Number	#520 85520	#531 85531	#541 85541	#541 85541	#430 82530	#422 82526
Seater Plug Part Number		7mm SIL 09696	308 SIL 09697	308 SIL 09697	357 SIL 90019*	44 SIL 90031*

Older die sets utilizing a 1/4" - 28 threaded seater plug require #09698 for .357 SIL and #09699 for .44 SIL.

ALTERNATE BULLET SIZES FOR CAST BULLETS

Caliber	Size	Sizer Die	Part Number
.22	.224"	.224" dia.	82200
6mm	.243"	.243" dia.	82201
.25	.257"	.257" dia.	82203
270	.277"	.277" dia.	82205
7mm	.284"	.284" dia.	82208
.30	.308"	.308" dia.	82211
.30	.310"	.310" dia.	82213
.30	.311"	.311" dia.	82214
.32	.312"	.312" dia.	82242
.32	.313"	.313" dia.	82215
.32	.314"	.314" dia.	82216
38/357	.354"	.354" dia.	82219
38/357	.355"	.355" dia.	82220
.38	.356"	.356" dia.	82221
357	.357"	.357" dia.	82222
375/38-55	.375"	.375" dia.	82224
.40	.408"	.408" dia.	82249
44-40	.427"	.427" dia.	82227
.44	.429"	.429" dia.	82228
.44	.431"	.431" dia.	82230
.45	.450"	.450" dia.	82231
.45	.451"	.451" dia.	82232
45 Colt	.452"	.452" dia.	82233
.45	.457"	.457" dia.	82235
500 S&W/50 AE	.501"	.501" dia.	82250

LUBE-A-MATIC® SIZER DIE & TOP PUNCH

LUBE-A-MATIC SIZER DIE LUBE-A-MATIC TOP PUNCH SILHOUETTE BULLET SEATER PLUG

ABBREVIATION GUIDE:

CSA	• C Sharps Arms	SWC	• Semi-Wadcutter
TG	• Target	WC	• Wadcutter
SPL	• Special	SP	• Semi-Point
U	• Universal	BB	• Bevel Base
PT	• Pointed	M	• Minie Ball
CAV	• Cavalry	R	• Round Ball
CN	• Conical Nose	SIL	• Silhouette
SAA	• Single Action Army	K	• Keith Type
FN	• Flat Nose	BPS	• Black Powder Silhouette
RN	• Round Nose	CM	• Cowboy Mould

All RCBS® Bullet Moulds are machined to exacting specifications ensuring accurate and clean casts time after time.

NOTE: All moulds are shown slightly smaller than actual size. Unless noted otherwise, all RCBS bullet moulds are double cavity type. Each mould is identified by a five or six digit number, followed by two or three letters. The first two or three digits identify bullet caliber, the last three are bullet weight in grains. (Round Balls are identified by caliber only.) Bullet weights are established by the following methods:

- Rifle & Silhouette Bullets—Linotype alloy
- Pistol, Black Powder Silhouette and C Sharps Arms Bullets—An alloy of one part tin to ten parts lead
- Cowboy Bullets—An alloy of one part tin to twenty parts lead
- Round & Minie Balls—Pure lead. +Available in single cavity only

BULLET CASTING

NORTH-SOUTH SKIRMISH BULLET MOULDS



Diameter	Mould	Part Number
.580"	.580-416 Hodgdon+	82162

ROUND BALL MOULDS



Diameter	Mould	Part Number
.457"	.457-130	82140

COWBOY BULLET MOULDS



Caliber	25-20 Win.	30-30 Win
Mould	25-85-CM	30-150-CM
Part Number	82301	82302
Sizer Die	.258"	.309"
Part Number	82204	82212
Top Punch	#630	#631
Part Number	85630	85631

MINIE BALL MOULDS



Diameter	Mould	Part Number
.575"	.58-500-M+	82103

COWBOY BULLET MOULDS



Caliber	32 H & R Mag/ .32-20 Win	38 Special/ 357 Magnum	38 Special/ 357 Magnum	38-40 WCF	44-40 WCF/ 44 Russ/ 44 Special/ 44 Magnum	45 S&W Sch/ 45 Long Colt	56-50 Spencer
Mould	-	-	38-158-CM	40-180-CM	44-200-CM	45-230-CM	50-350-CM+
Part Number	-	-	82305	82306	82307	82308	82309
Sizer Die	.314"	.358"	.358"	.401"	.428"/.430"	.452"/.454"	.512"
Part Number	82216	82223	82223	82245	82244/82229	82233/82234	82255
Top Punch	#632	#633	#633	#635	#636	#637	#624
Part Number	85632	85633	85633	85635	85636	85637	85624

+ Single cavity mould



WARNING: MELTING LEAD AND CASTING LEAD OBJECTS WILL EXPOSE YOU AND OTHERS IN THE AREA TO LEAD, WHICH IS KNOWN TO CAUSE BIRTH DEFECTS, OTHER REPRODUCTIVE HARM AND CANCER. SEE INSTRUCTIONS ON REDUCING EXPOSURE SUPPLIED WITH PRODUCT.



A

A AMMOMASTER® CHRONOGRAPH

Self-contained chronograph that checks velocity of arrows, paintball guns, rifles and pistols. Diffuser and supports store within housing. Detached keypad with 20-foot cord. Velocity range of 50-7,000 fps.

- 81190 AMMOMASTER CHRONOGRAPH**
- 81191 SIDE SUPPORT (2 PACK)**
- 81192 DIFFUSER**
- 81193 SKYSCREEN START**
- 81194 SKYSCREEN STOP**

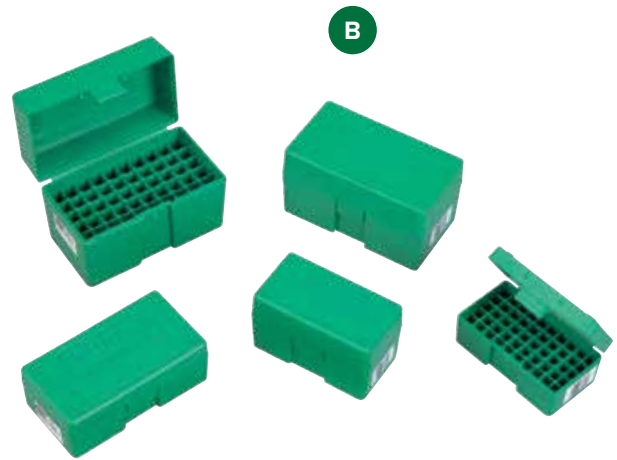

B

B AMMO BOXES

These tough, plastic boxes have flush exteriors with recessed latches. They're designed to stack easily, and feature an anti-rattle bullet-tip nest, empty case support, and long-lasting hinge. Available in five sizes:

- 86901 SMALL RIFLE**
- 86902 MEDIUM RIFLE**
- 86903 LARGE RIFLE**
- 86905 MEDIUM PISTOL**
- 86906 LARGE PISTOL**

See Reference Chart on page 40-41



C

C PRECISIONEERED® HANDLOADING DVD

Whether you're an old pro or just getting started in handloading, this is the best 30-minute time investment you'll ever make. Precisioneered® Handloading is both entertaining and educational—a must see for the do-it-yourselfer.

- 99910 PRECISIONEERED® HANDLOADING DVD**

REALLY COOL BENCHIN' STUFF

GOT A QUESTION?

Contact our world-class customer service team!

Phone 800-379-1732, Monday through Friday

On-line rcbs.com/Help/Customer-Service.aspx

Email rcbs.tech@vistaoutdoor.com

rcbs.com

